



Sheringham Shoal and Dudgeon Offshore Wind Farm Extension Projects

Outline Construction Traffic Management Plan (Revision C) (Clean)

Revision C

Deadline 3

May 2023

Document Reference: 9.16

APFP Regulation: 5(2)(q)

Title: Sheringham Shoal and Dudgeon Offshore Wind Farm Extension Projects Outline Construction Traffic Management Plan (Revision C) (Clean Version)	
PINS Document no.: 9.16	
Revision: C	
Document no.: C282-RH-Z-GA-00126	
Date:	Classification
May 2023	Final
Prepared by:	
Royal HaskoningDHV	
Approved by:	Date:
Sheery Atkins, Equinor	May 2023



Table of Contents

OUTLINE CONSTRUCTION TRAFFIC MANAGEMENT PLAN	8
1 Introduction.....	8
1.1 Background	8
1.2 Purpose of the Outline Construction Traffic Management Plan	9
1.3 OCTMP Scope.....	10
1.4 CTMP Governance	10
1.5 Structure of the OCTMP	12
2 Control of HGV Trips.....	13
2.1 Introduction	13
2.2 HGV Traffic Generation	13
2.3 Measures.....	13
3 Control of Personnel Trips	18
3.1 Introduction and Background.....	18
3.2 Measures.....	18
4 Traffic Management	21
4.1 Introduction	21
4.2 Control of Noise Impacts.....	21
4.3 Control of Material on the Highway.....	21
4.4 Accesses and Road Crossings.....	22
4.5 Access Management Measures	23
4.6 Cable Crossings.....	24
4.7 Junction Assessments	25
4.8 Road Safety.....	26
4.9 Parking and Loading.....	27
4.10 Traffic Incident Management Plan (TIMP).....	27
4.11 Cumulative Traffic.....	28
4.12 Traffic Sensitive Streets	29
4.13 Highway Condition Surveys.....	30
5 Monitoring, Enforcement and Action Plan.....	30
5.1 Introduction	31
5.2 Monitoring.....	31
5.3 Enforcement	33
5.4 Action Plan.....	33
References	36

Table of Tables

Table 1-1: Summary of OCTMP Changes.....	8
Table 3-1: Personnel Travel Plan Measures	18
Table 4-1: TIMP Measures Adopted During Events.....	27
Table 4-2: Traffic Sensitive Links - Mitigation.....	29

Table 5-1: OCTMP Action Plan 33

Table of Plates

Plate 1-1: CTMP Governance Structure..... 11

OCTMP Figures

Figure 1 HGV Routes

OCTMP Annexes

Annex A Peak Vehicle Movements Per Link

Annex B Outline Access Designs

Annex C Road Crossing Schedule

Glossary of Acronyms

AIL	Abnormal Indivisible Load
BNL	Basic Noise Level
dB	Decibel
CLO	Community Liaison Officer
CTMP	Construction Traffic Management Plan
CTMPCo	Construction Traffic Management Plan Co-ordination
DCO	Development Consent Order
DEL	Dudgeon Extension Limited
DEP	Dudgeon Offshore Wind Farm Extension Project
EIA	Environmental Impact Assessment
ES	Environmental Statement
ESDAL	Electronic Service Delivery for Abnormal Loads
HDD	Horizontal Directional Drilling
HGV	Heavy Goods Vehicle
HP3	Hornsea Project 3
LV	Light Vehicle
NCC	Norfolk County Council
NH	National Highways
OCTMP	Outline Construction Traffic Management Plan
PC	Principal Contractor
SEL	Scira Extension Limited
SEP	Sheringham Shoal Offshore Wind Farm Extension Project
TIMP	Traffic Incident Management Plan
TTSA	Traffic and Transport Study Area
UK	United Kingdom

Glossary of Terms

Dudgeon Offshore Wind Farm Extension Project (DEP)	The Dudgeon Offshore Wind Farm Extension onshore and offshore sites including all onshore and offshore infrastructure.
Evidence Plan Process (EPP)	A voluntary consultation process with specialist stakeholders to agree the approach, and information to support, the EIA and HRA for certain topics.
Horizontal directional drilling (HDD)	Trenchless technique used to install cables – in this case referring to the installation of the export cables at the landfall.
Horizontal directional drilling (HDD) zones	The areas within the onshore cable corridor which would house HDD entry or exit points.
Landfall	The point at the coastline at which the offshore export cables are brought onshore, connecting to the onshore cables at the transition joint bay above mean high water.
Links	A road or group of roads with similar traffic characteristics and composition.
Onshore cable corridor	This is the area which will contain the offshore export cables or interlink cables, including the adjacent Offshore Temporary Works Area.
Onshore export cables	The cables which would bring electricity from the offshore substation platform(s) to the landfall. 220 – 230kV.
Onshore Substation	Compound containing electrical equipment to enable connection to the National Grid.
Traffic and Transport Study Area (TTSA)	Area where potential impacts from the project could occur, as defined for each individual EIA topic.
Sheringham Shoal Offshore Wind Farm Extension Project (SEP)	The Sheringham Shoal Offshore Wind Farm Extension site onshore and offshore sites including all onshore and offshore infrastructure.
The Applicant	Equinor New Energy Limited. As the owners of SEP and DEP, Scira Extension Limited and Dudgeon Extension Limited are the named undertakers that have the benefit of the DCO. References in this document to obligations on, or commitments by, ‘the Applicant’ are given on behalf of SEL and DEL as the undertakers of SEP and DEP.
Vehicle (HGV, Traffic) trip	A single trip (i.e. the arrival or departure from site) for the transfer of employees or goods.

Vehicle (HGV, Traffic) trips	A two-way trip (i.e. the arrival and departure from site) for the transfer of employees or goods.
------------------------------	---

OUTLINE CONSTRUCTION TRAFFIC MANAGEMENT PLAN

1 Introduction

1.1 Background

1. Equinor New Energy Limited (hereafter the Applicant) applied, on behalf of the partners in the operational Sheringham Shoal and Dudgeon Offshore Wind Farms, for an Agreement for Lease for the extension of these two wind farms.
2. The Applicant is leading on the development work for the proposed Sheringham Shoal Offshore Wind Farm Extension Project (SEP) and Dudgeon Offshore Wind Farm Extension Project (DEP).
3. Electricity will flow from the wind turbines via infield cables to offshore substation platform(s). Interlink cables will link the separate project areas. At the offshore substation(s), the generated power will be transformed to a higher alternating current voltage. The power will be exported via up to two export cables, in two separate trenches, to landfall west of Weybourne on the North Norfolk coast. At landfall, the offshore export cables will meet and be joined up with the onshore export cables in transition joint bays.
4. The onshore export cables travel approximately 60km inland to a high voltage alternating current onshore substation near to the existing Norwich Main substation. The onshore substation will be constructed to accommodate the connection of both SEP and DEP to the national transmission grid.
5. A full description of SEP and DEP is provided in the Environmental Statement (ES), **Chapter 4 Project Description** (document reference 6.1.4).
6. Following the submission of the Development Consent Order application, comments have been provided from highway stakeholders and interested parties in regard to the content of the Outline Construction Traffic Management Plan (OCTMP). **Table 1-1** provides a summary of these amendments.

Table 1-1: Summary of OCTMP Changes

OCTMP Revision Number	Summary of changes	Relevant Section of the OCTMP
Revision B	Clarifications with regard to the approach to managing cumulative traffic impacts	Throughout the OCTMP
	Corrections to vehicle and HGV caps	Annex A Peak Vehicle Movements Per Link and Table 4-2
	Amendments to restrict HGV routeing at Weston Longville, Plumstead and north via link 12	Figure 1
	Noise mitigation measures via link 137	Section 4.2
	Additional controls on access at ACC25b	Section 4.4
Revision C	Inclusion of outline access concept drawings, including amendments to ACC33 and ACC47	Annex B Outline Access Designs and Section 4.4
	Additional controls on access at ACC25b	Section 4.4
	Contingency mechanisms to utilise routes not assessed within the ES Chapter 24 Traffic and	Section 2.3.3

OCTMP Revision Number	Summary of changes	Relevant Section of the OCTMP
	Transport (document reference 6.1.24), ensuring the highway authorities have approval of any proposed changes to routeing.	
	Measures to manage light vehicle (LV) movements through Oulton	Section 3.2.3
	Minor amendments to monitoring reports	Section 5.2.7
	Clarification of whether roads would be crossed using open cut or trenchless techniques.	Annex C Road Crossing Schedules and Section 4.6

1.2 Purpose of the Outline Construction Traffic Management Plan

7. ES **Chapter 24 Traffic and Transport** (document reference 6.1.24) contains an assessment of the potential impacts and associated mitigation for the construction, operation, and decommissioning phases of SEP and DEP.
8. The Outline Construction Traffic Management Plan (OCTMP) contains the control measures and monitoring procedures for managing the potential traffic and transport impacts of constructing SEP and DEP. The objective of the OCTMP is to define a strategy to ensure that the construction traffic parameters (e.g. traffic numbers and routes) assessed within the ES are managed and not exceeded.
9. The OCTMP will form the basis for a final Construction Traffic Management Plan (CTMP), which will be prepared and submitted prior to the commencement of the relevant part of the construction works for approval by the relevant highway authorities, i.e. Norfolk County Council (NCC) and National Highways (referred to hereafter as the highway authorities). This is secured by Requirement 15 of the draft Development Consent Order (DCO) which states:
 15. - (1) No phase of the onshore works may commence until for that phase the construction traffic management plan (which must be in accordance with the outline construction traffic management plan), as appropriate for the relevant phase, has for that phase been submitted to and approved by the relevant planning authority in consultation with the relevant highway authority
 - (2) Any plan submitted under sub-paragraph (1) may cover one or more phase of the onshore works.
 - (3) Each plan approved under sub-paragraph (1) must be implemented upon commencement of the relevant phase of the onshore works.
 - (4) If any of the accesses identified in the outline construction traffic management plan are required for pre- commencement archaeological investigations, a specific plan for such accesses which must accord with the relevant details set out in the outline construction traffic management plan must be submitted to and approved by the relevant planning authority, in consultation with the relevant highway authority, prior to the construction and use of such accesses. The accesses identified must be constructed and used in accordance with the details contained in the specific plan so approved.
10. The final CTMP will set standards and procedures for:

- Managing the numbers and routing of Heavy Goods Vehicles (HGVs) during the construction phase;
 - Managing the movement of employee traffic during the construction phase;
 - Details of localised road improvements necessary to facilitate safe use of the existing road network; and
 - Detail of measures to manage the safe passage of Heavy Goods Vehicle (HGV) traffic via the local highway network.
11. The OCTMP also includes a suite of access and road crossing design concepts and details of the proposed technical approvals process. At this stage it is proposed that the final technical approvals for the access and crossing designs would be included within the final CTMP (discharging Requirement 15 and 16). However, access and road crossing approvals could be independent of the final CTMP whilst still meeting the stipulations of Requirement 16 of the draft DCO which states:
16. - (1) Construction of any new permanent or temporary means of access to a highway, or alteration, or use of an existing means of access to a highway, must not commence until an access plan for that access has been submitted to and approved by the relevant highway authority.
- (2) The access plan must include details of the siting, design, layout, visibility splays, access management measures, lighting, signing, safety measures and a maintenance programme relevant to the access it relates to.
- (3) The highway accesses (including visibility splays) must be constructed and maintained in accordance with the approved details.

1.3 OCTMP Scope

12. The worst-case construction scenarios assessed in the ES, **Chapter 24 Traffic and Transport** (document reference 6.1.24) are:
- Build SEP or build DEP in isolation; and
 - Build SEP and DEP concurrently.
13. Unless explicitly specified, the measures and controls contained within this OCTMP would be applicable to the construction of SEP or DEP in isolation and SEP and DEP.
14. The scope of the OCTMP does not extend to the base port to be utilised for offshore construction and maintenance of SEP and DEP. The Applicant is currently considering ports suitable for the construction base for the offshore elements of SEP and DEP, but no decision has been made at the time of writing over which to utilise. As such, the DCO application for SEP and DEP does not seek development consent for activities at potential construction ports. Where necessary, any such development activity would be subject to separate consent(s) such as a planning permission or a Harbour Revision Order and would therefore be subject to a separate Transport Assessment and/or CTMP.

1.4 CTMP Governance

15. Prior to the commencement of the relevant part of the construction works a CTMP Co-ordinator (CTMPCo) will be appointed by the Principal Contractor (PC). Their

key responsibilities will include:

- Managing the implementation of the approved CTMP;
- Collating monitoring data and preparing a monitoring report (as outlined in **Section 5**);
- Acting as a point of contact for the local community;
- Regular liaison and reporting to the Applicant;
- Supporting the Applicant with Highway Stakeholder engagement; and
- Acting as a point of contact for construction workers and sub-contractors.

16. The CTMPCo will also be assisted in their role by a Community Liaison Officer (CLO). The CLO will be appointed by the Applicant. Section 2.4 of the **Outline Code of Construction Practice** [document reference 9.17] includes further details in relation to local community liaison and the role of the CLO.

17. To ensure clarity of the responsibilities of the OCTMP, its governance structure is set out in **Plate 1-1**.

Plate 1-1: CTMP Governance Structure

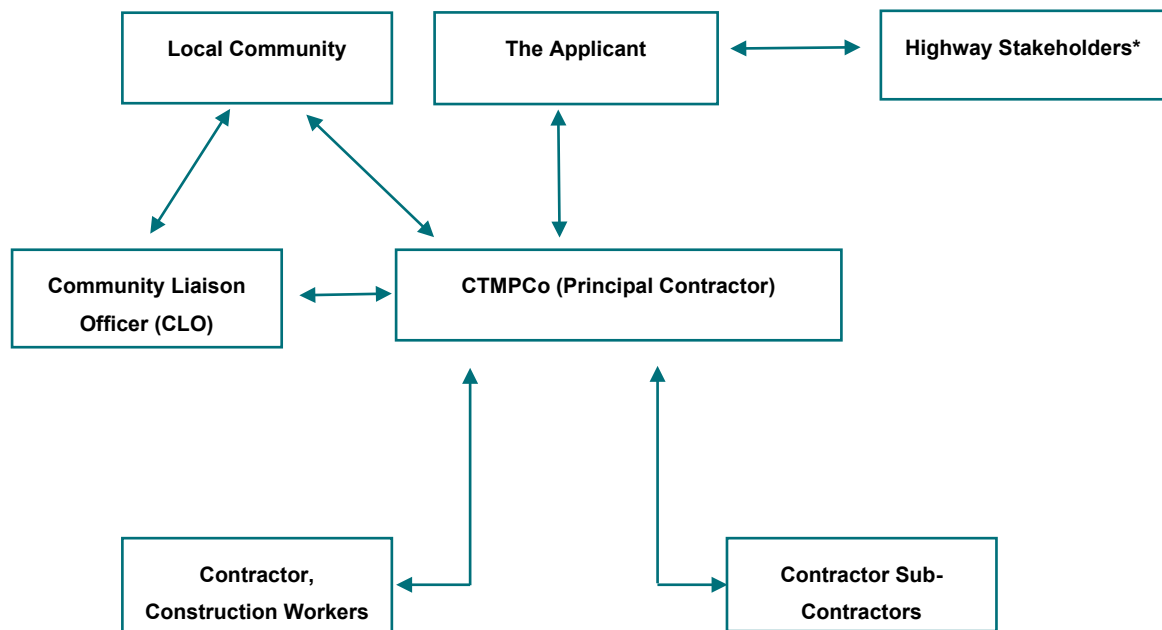

*Highways Stakeholders will include NCC, National Highways, relevant local District, Town and Parish Councils and developers of other consented Nationally Significant Infrastructure Projects within the traffic and transport study area.

18. Full details of all the responsibilities of the CTMPCo and CLO and associated timescales are provided as an Action Plan in **Section 5.4** of this document. Contact details for the CTMPCo and CLO will be submitted to the highway stakeholders for their records prior to the commencement of the relevant part of the construction works.

1.5 Structure of the OCTMP

19. Following this introduction, the structure of the OCTMP is as follows:

- **Section 2** defines a target and measures to manage HGV demand;
- **Section 3** defines a target and measures to manage employee traffic demand;
- **Section 4** sets out access and traffic management proposals; and
- **Section 5** sets-out how the OCTMP will be monitored and provides an Action Plan for its implementation.

2 Control of HGV Trips

2.1 Introduction

20. The OCTMP provides a level of detail as to the traffic management measures that will be implemented to control HGV trips during the construction phase. In doing so, the OCTMP will set the management measures and performance required of the PC.
21. These measures are an absolute requirement established from the parameters outlined in **Section 24.6.1** of ES **Chapter 24 Traffic and Transport** (document reference 6.1.24), to be adopted by the appointed PC and only revised with the prior agreement of the highway authorities.

2.2 HGV Traffic Generation

22. **Table 24.19** and **Table 24.20** of **Chapter 24 Traffic and Transport** (document reference 6.1.24) sets out the forecast number of peak and average daily construction HGV trips (for all of the 140 links within the Traffic and Transport Study Area (TTSA)) for SEP or DEP in isolation or SEP and DEP concurrently respectively.
23. The ES identified that to mitigate potential severance and amenity impacts (of SEP and DEP construction traffic) it is necessary to reduce peak daily HGV trips on some links.
24. The resultant peak daily HGV trips per link are summarised in **Annex A Peak Vehicle Movements Per Link**. **Annex A Peak Vehicle Movements Per Link** also highlights which links have been subject to a reduction in peak construction HGV demand and the rationale for this mitigation.
25. In addition to mitigation of SEP and DEP traffic, ‘cumulative caps’ on HGV movements along the following links were also identified to manage the potential cumulative impacts associated with the construction of Norfolk Vanguard/Boreas (the Norfolk Projects) and Hornsea Project Three:
- Link 4 (A148 from A1067 to B1149);
 - Links, 49, 54, 56 and 59 (B1149 from A148 to B1354); and
 - Link 53 (B1145 from the B1149 to Cawston).
26. These caps on cumulative traffic flows are also reflected in **Annex A Peak Vehicle Movements Per Link**.

2.3 Measures

2.3.1 HGV Numbers

27. To ensure compliance with the assessed worst-case scenario for HGV trips (**Annex A Peak Vehicle Movements Per Link**), a booking system for deliveries would be established by the CTMPCo. The booking system would enable a daily profile of deliveries to be maintained and allow the CTMPCo to ensure that the required deliveries are forecast and planned.
28. To ensure compliance with the cumulative caps (outlined in **Annex A Peak Vehicle Movements Per Link**), the CTMPCo will liaise with Hornsea Project Three and

Norfolk Projects to establish their potential forward programme for deliveries via these links. Where potential exceedances of the cumulative caps are identified, the CTMPCo for SEP and DEP will reschedule deliveries to ensure the cumulative caps are not exceeded.

29. To provide the highway authorities with an indication of when peak deliveries may occur within the construction programme, the final CTMP would also be updated to include indicative profiles for monthly deliveries per link for the construction duration.

2.3.2 HGV Timings

30. Requirement 20 of the draft DCO outlines the working hours and hours during which construction related traffic can take place for the construction of SEP and DEP. Requirement 20, notes:

(1) Construction work for the onshore works must only take place between 0700 hours and 1900 hours Monday to Friday, and 0700 hours to 1300 hours on Saturdays, with no activity on Sundays or bank holidays, except as specified in paragraphs (2) to (4).

(2) Outside the hours specified in paragraph (1), construction work may be undertaken for essential activities including but not limited to—

- a) *Continuous periods of operation that are required as assessed in the environmental statement, such as concrete pouring, drilling, dewatering, cable jointing and pulling cables (including fibre optic cables) through ducts;*
- b) *Delivery to the onshore works of abnormal loads that may otherwise cause congestion on the local road network;*
- c) *Works required that may necessitate the temporary closure of roads;*
- d) *Onshore works requiring trenchless installation techniques;*
- e) *Onshore works at the landfall;*
- f) *Commissioning or outage works associated with the National Grid substation connection works;*
- g) *Electrical installation; or*
- h) *Emergency works.*

(3) Outside the hours specified in paragraph (1), construction work may be undertaken for non- intrusive activities including but not limited to—

- a. *Fitting out works within:*
 - i. *The onshore HVAC substation buildings comprised within Work Nos. 15A and 15B in the event of scenario 1 or scenario 2; or*
 - ii. *The integrated onshore HVAC substation building comprised within Work No. 15C in the event of scenario 1 or scenario 4; and*
- b. *Daily start up or shut down.*

(4) Save for emergency works, full details, including but not limited to type of activity, vehicle movements and type, timing and duration and any proposed mitigation, of all essential construction activities under paragraph (2) and undertaken outside of the hours specified in paragraph (1) must be agreed with the relevant planning

authority in writing in advance, and must be carried out within the agreed time.

31. With the exception of clauses above, HGV construction traffic movements will not be permitted outside of the hours referred to in Requirement 20. This does not preclude HGV travel to and from the site of the relevant work via the wider highway network which may occur during the mobilisation/demobilisation hours.
32. Any HGVs which are projected to arrive on site outside of core working hours will be required to park at an appropriate lorry park, services and other designated overnight parking locations until they can complete their journey within appropriate restrictions. These locations will be agreed with the relevant highway authorities prior to the commencement of the relevant part of the construction works and will be communicated to drivers within their delivery instructions (outlined within **Section 2.3.3**).

2.3.3 Control of HGV Routes

33. The proposed routes to be used by HGVs have been carefully selected to minimise impacts upon sensitive receptors. Furthermore, at the request of highway stakeholders and local communities the following routes and locations will be prohibited for use by SEP and DEP HGV traffic:
 - Attlebridge;
 - Barford;
 - Blind Lane;
 - Cantley Lane South;
 - Cawston;
 - Horsford;
 - Oulton;
 - Plumstead; and
 - Weston Longville.
34. The proposed HGV routes to each access will be limited to the assessed links within the ES, as shown in **Figure 1** of this OCTMP. To ensure compliance with the HGV delivery routes, the following measures are proposed:
 - Direction signing will be implemented to direct construction traffic to the respective accesses along the assessed delivery routes (the location and design of these signs will be agreed with the relevant highway authority prior to the commencement of the relevant part of the construction works);
 - The delivery routes and timings will be communicated (by the CTMPCo) through the issuing of delivery instructions to all companies and/or drivers involved in the transport of materials and plant to and from site by HGV construction vehicles;
 - The registration numbers for all HGVs making deliveries will be recorded by the CTMPCo. This will allow for checking and enforcement of any reported breaches of the agreed delivery routes;
 - CTMPCo will require that where vehicle tracking is fitted to vehicles, that the

systems are operational and the suppliers/drivers make the data available to the CTMPCo. Vehicle tracking will allow the CTMPCo to investigate any breaches; and

- The CTMPCo will provide an 'identifier' that will be placed within the window of all delivery vehicles to enable residents to identify if an HGV is engaged on work on SEP and DEP and will be submitted to and approved by the highway authorities as part of the final CTMP.

35. In the event that the CTMPCo becomes aware that the links assessed within the ES (**Figure 1**) are unavailable (e.g. due to road closures by others) the CTMPCo will initially seek to reschedule works to utilising the affected links. Where this may not be possible the following approach is proposed:

- The CTMPCo will identify contingency diversion routes having regard for the road hierarchy (e.g. where possible utilising roads of an equivalent standard);
- The CTMPCo will submit details of the proposed contingency diversion routes to the highway authorities who would be requested to advise if they consider the routes are suitable or if they require any further assessment; and
- If further assessment is required, the CTMPCo will undertake the required assessment utilising the methodology detailed within the ES and request the highway authorities to review the outputs and confirm acceptance or otherwise.

2.3.4 Driver Inductions

36. All HGV drivers for SEP and DEP will be formally inducted. The induction will establish a clear set of responsibilities that all drivers will be required to follow, such as:

- Timings, pre-booked slots;
- Clarification of approved HGV routes;
- Highway safety concerns;
- Adherence to speed limits; and
- Details of reporting accidents and 'near misses'.

2.3.4.1.1 Delivery Packs

37. To support the strategy to control HGV routes, each driver will be issued with a delivery pack. This pack will be a convenient size so that it can be stored in the truck cab and include the following information:

- A plan showing the delivery routes and the location of the site access;
- Details of appropriate lorry park, services and other designated overnight parking locations where drivers are permitted to stop;
- A copy of the identifier to display in the vehicle window;
- Details of restrictions on delivery hours (set out in **Section 2.3.2** of this document); and

- Details of disciplinary measures for non-compliance (set out in **Section 5.3** of this document).

38. Compliance with the agreed HGV delivery routes will be subject to the monitoring and enforcement measures set out in **Section 5** of this document.

2.3.5 Abnormal Loads

2.3.5.1.1 Special Order Abnormal Loads

39. ES **Chapter 24 Traffic and Transport** (document reference 6.1.24) identified that the construction of the onshore substation would require the delivery of one transformer for SEP and one for DEP. Each transformer delivery would be classified as a Special Order¹ Abnormal Indivisible Load (AIL) delivery due to the size of the vehicle.

40. The movement of Special Order AILs would be outside of the restrictions (routes and times) contained within this OCTMP and would be subject to separate agreement with the relevant highway authorities and police through the Electronic Service Delivery for Abnormal Loads (ESDAL) system.

2.3.5.1.2 Non-Special Order Abnormal Loads

41. There would also be a potential requirement for non-Special Order abnormal load movements associated with the delivery of cable drums and plant. These abnormal load deliveries would not however constitute a Special Order.

42. The final size of cable drums has not been determined at this stage and would be subject to further detailed design post consent. It has therefore been agreed with NCC that the PC will consult with NCC prior to the movement of the load, in regard to routes to be used and size of vehicles.

43. The movement of the non-Special Order abnormal loads would be subject to the same delivery route restrictions as HGVs (outlined in **Section 2.3.3**) however the timing of movements may be outside the standard hours (outlined in **Section 2.3.2**) and subject to separate agreement with the relevant highway authorities and police through the ESDAL system.

44. Prior to the movement of any AILs or abnormal loads, the CTMPCo will ensure stakeholders are notified through ESDAL and agree appropriate timings, routes and asset protection measures (with the relevant highway authorities, police and Network Rail) appropriate to the type of load.

¹ *The Road Vehicles (Authorisation of Special Types) (General) Order 2003 (SI 1998) limits gross weight of an AIL to 150 tonnes, axle weight to 16,500kg, length to 30m and/or width to 6.1m, above which a Special Order is required from National Highways.*

3 Control of Personnel Trips

3.1 Introduction and Background

- 45. **Section 24.6.1** of ES **Chapter 24 Traffic and Transport** (document reference 6.1.24) assessed a worst-case scenario of all employees travelling by car on their own (i.e. single occupancy). No allowance for employees to car-share or use other sustainable modes of transport were applied to the assessment.
- 46. Employee vehicle trips are expressed as light vehicles (LV) trips. The term LVs is a collective term used to describe the range of vehicle types that could be used by construction employees (e.g. cars, vans, pick-ups, minibuses, etc).
- 47. **Table 24.19** and **Table 24.20** of ES **Chapter 24 Traffic and Transport** (document reference 6.1.24) set out the forecast number of peak and average daily construction LV trips (for all of the 140 links within the TTSA) for SEP or DEP in isolation of SEP and DEP respectively.
- 48. The ES identified that to mitigate potential severance, amenity and driver delay (capacity) impacts (of SEP and DEP construction traffic) it is necessary to reduce peak daily LV trips on some links.
- 49. The resultant peak daily LV trips per link are summarised in **Annex A Peak Vehicle Movements Per Link**. **Annex A Peak Vehicle Movements Per Link** also highlights which links have been subject to reduced LV flows and the rationale for this mitigation.
- 50. The OCTMP sets out measures to secure the adoption of more sustainable travel options (than single occupancy LVs).

3.2 Measures

3.2.1 LV Vehicle Numbers

- 51. To ensure compliance with the assessed worst-case scenario for LV trips (**Annex A Peak Vehicle Movements Per Link**), the CTMPCo will be required to establish a resource forecast for the number of employees that could be travelling to SEP and DEP. The resource forecast will enable the CTMPCo to identify any potential exceedances.
- 52. Where potential exceedances are identified, the CTMPCo will be required to either:
 - Reschedule activities to reduce the overlap or intensity of activities; or
 - Implement ‘enhanced travel planning’ measures, e.g. car-sharing, private minibus transport.
- 53. **Table 3-1** outlines as range of best practice measures that could be adopted to reduce the number of single occupancy car trips. These types of measures would also form the basis for enhanced travel planning (if required).

Table 3-1: Personnel Travel Plan Measures

Measure	Rationale
Identify car-share, pickup	The CTMPCo will identify and group employees who are in nearby accommodation and explore opportunities for car-sharing including the



Measure	Rationale
locations	assignment of crew vans and designated drivers.
Drivers required to park within designated areas	All drivers will be required to park within designated areas. Drivers not parking within the designated areas, will be subject to enforcement action as set out in Section 5.3 of this document.
Walking/ cycle facilities	It is recognised that the transient nature of the construction workforce will reduce the potential opportunities for walking and cycling. However, the CTMPCo will encourage employees to walk and cycle by providing changing facilities and secure cycle parking. The level of cycle parking requirements will be established by the CTMPCo based upon personnel origins and reviewed throughout construction.
Guaranteed lift home	To allow personnel who car-share to get home in an emergency, a guaranteed lift home will be offered.
Staff noticeboard	Staff notice boards will be provided within communal areas, these will include details of the car-sharing options including details of parking requirements and the guaranteed lift home. The notice boards will also include details of local walking and cycling routes and bus and train times (where options exist).
Welfare facilities	To avoid the need for employees to drive off site during the working day, the CTMPCo will ensure welfare facilities are available where workers can store, prepare and eat lunch.

3.2.2 LV Vehicle Timings

54. Requirement 20 of the draft DCO outlines the working hours and hours during which construction related traffic can take place for the construction SEP and DEP. Requirement 20, notes:

- 1) Construction work for the onshore works must only take place between 0700 hours and 1900 hours Monday to Friday, and 0700 hours to 1300 hours on Saturdays, with no activity on Sundays or bank holidays, except as specified in paragraphs (2) to (4).
- 2) Outside the hours specified in paragraph (1), construction work may be undertaken for essential activities including but not limited to—
 - a) *Continuous periods of operation that are required as assessed in the environmental statement, such as concrete pouring, drilling, dewatering, cable jointing and pulling cables (including fibre optic cables) through ducts;*
 - b) *Delivery to the onshore works of abnormal loads that may otherwise cause congestion on the local road network;*
 - c) *Works required that may necessitate the temporary closure of roads;*
 - d) *Onshore works requiring trenchless installation techniques;*
 - e) *Onshore works at the landfall;*
 - f) *Commissioning or outage works associated with the National Grid substation connection works;*
 - g) *Electrical installation; or*
 - h) *Emergency works.*
- 3) Outside the hours specified in paragraph (1), construction work may be undertaken for non- intrusive activities including but not limited to:

a) *Fitting out works within:*

- i. *The onshore HVAC substation buildings comprised within Work Nos. 15A and 15B in the event of scenario 1 or scenario 2; or*
- ii. *The integrated onshore HVAC substation building comprised within Work No. 15C in the event of scenario 1 or scenario 4; and*

b) *Daily start up or shut down.*

(4) Save for emergency works, full details, including but not limited to type of activity, vehicle movements and type, timing and duration and any proposed mitigation, of all essential construction activities under paragraph (2) and undertaken outside of the hours specified in paragraph (1) must be agreed with the relevant planning authority in writing in advance, and must be carried out within the agreed time.

- 55. The assessment of driver delay (capacity) presented within ES **Chapter 24 Traffic and Transport** (document reference 6.1.24) is predicated upon industry experience that highlights that the majority of the construction workforce would arrive before the morning network peak defined by NCC as (07:30 – 09:00) and depart after the evening peak hour (16:25 -17:25).
- 56. The CTMPCo will therefore encourage staff to arrive prior to 07:30 and depart after 17:25 in the evening. Notwithstanding, there may be some employees who would work a shorter day, or trips outside of the standard hours. To ensure that there would not be an adverse impact upon capacity, the CTMPCo would limit these movements to no more than 25% of the peak daily LV demand (outlined in **Annex A Peak Vehicle Movements Per Link**).

3.2.3 LV Routeing

- 57. NCC have requested that LVs associated with the construction of the SEP and DEP are restricted from travelling through Oulton. The following measures are therefore proposed:
 - As part of the site induction process, the CTMPCo will inform construction employees travelling to accesses ACC24 to ACC26 (in the vicinity of Oulton) to approach and exit in the direction of the B1149; and
 - Signage will be placed in the vicinity of access ACC24 and ACC26 to direct SEP and DEP traffic to travel west toward along the B1354 to the B1149 and south along The Street and to the B1149, respectively.
- 58. Where employees have legitimate reasons to travel north on The Street or east along the B1354 toward Oulton employees will be required (through their site induction) to notify and agree this with the CTMPCo. The CTMPCo will record any agreed exceptions and the associated vehicle registration number. Examples, of exceptions could include employees with an origin in the local area.

4 Traffic Management

4.1 Introduction

59. This section sets out the standards and procedures for managing the interaction between construction traffic, existing highway users and local communities.

4.2 Control of Noise Impacts

60. **Chapter 23 Noise and Vibration** (document reference 6.1.23) identifies a potentially significant impact due to the forecast increase in construction traffic upon a residential property along link 137. The impact is predicted if a change in road traffic noise level of at least three decibels (dB) occurs at a residential property for a duration of at least 40 days in any six month period.

61. To avoid potentially significant road traffic noise impacts upon this receptor, it is proposed that SEP and DEP construction traffic along link 137 will be capped. This cap could comprise either a reduction in LVs or HGVs, or a combination of both.

62. To inform the cap on LV and HGV numbers, it is proposed that prior to the commencement of the relevant parts of the construction works, road traffic noise levels will be calculated in accordance with the 'basic noise level' (BNL) calculation procedure in the Calculation of Road Traffic Noise², for comparison with the calculated BNL of 57.8 dB L_{A10,18h} provided in Table 23.2.3 of the ES Appendix 23.2 - Road Traffic Noise Assessment (document reference 6.3.23.2).

63. The caps would be detailed within the final CTMP and controlled by the measures outlined within section 2 and 3 and subject to the monitoring and enforcement process detailed within section 5.

64. Further measures to control noise and vibration are outlined within the **Outline Code of Construction Practice** (document reference 9.17).

4.3 Control of Material on the Highway

65. To prevent detritus and other material being deposited on the public highway the CTMPCo would be required to implement a series of site-specific measures. Prior to the commencement of the relevant parts of the construction works, the details of the measures that will be used for each access will be submitted to and agreed with the highway authorities.

66. It is envisaged that as a minimum, measures would include the following:

- Regular inspections of the public highway in the vicinity of the active site accesses to ensure cleanliness; and

² *Department of Transport, Welsh Office (1988). Calculation of Road Traffic Noise. HMSO, London*

- Road sweepers on call to clear any detritus and other material from the public highway.

67. Where deliveries are likely to be more intense, such as at compounds, further measures such as wheel washing facilities and dust suppression measures may also be provided.

4.4 Accesses and Road Crossings

68. A suite of outline access and road crossing concept designs have been developed for SEP and DEP and are detailed within **Annex B Outline Access Designs**.

69. It has been agreed with NCC and National Highways that these outline access and crossing concepts can be refined post consent, to be included in the final CTMP.

70. Following the submission of the DCO application, additional controls have been also agreed with NCC for access ACC25b. These measures include:

- Limiting the duration of use of access ACC25b;
- Ensuring the temporary traffic signals at ACC25b do not operate between the hours of 07:30 to 09:00 and 16:30 to 17:30; and
- No SEP and/or DEP traffic movements should travel to access ACC25b between 07:30 to 09:00 and 16:30 to 17:30.

71. Prior to the commencement of the relevant parts of the construction works, the technical approvals for the access and crossing designs will be submitted to and agreed with the highway authorities under Section 278 of the Highways Act (1980) or equivalent provisions under the DCO (e.g. DCO Requirement 16). The technical approval process will include submission of finalised drawings, showing full details of access and crossing improvements, including drainage, lighting, signing, and standard construction details.

72. The technical approval documentation will also include Stage 1 and 2 Road Safety Audit and a Road Safety Audit Response Report (on behalf of the designer's).

73. It has also been agreed with National Highways that if access is required from the Strategic Road Network (access ACC47, shown in **Figure 24.6** of ES **Chapter 24 Traffic and Transport** (document reference 6.2.24)), the technical approvals documentation should include a Safety Risk Assessment (known as a GG104).

74. In addition to the powers set out in the draft DCO, relevant powers under the Road Traffic Regulation Act (1984) will be sought to implement any temporary speed limit changes required.

75. All accesses and crossings identified for construction are temporary and following completion of construction works would be reinstated to their former state unless otherwise agreed with the highway authorities and the relevant landowner. The exception to this would be the access to the onshore substation which would remain in-situ for operation and maintenance of the onshore substation.

76. **Figure 24.6** of ES **Chapter 24 Traffic and Transport** (document reference 6.2.24)) shows three potential options to access the onshore substation. These are:

- Access ACC73 Mangreen Lane - this provides access to the existing National Grid substation, in addition to providing a potential route to the onshore substation;
 - Access ACC74 – an existing quarry access from the A140; and
 - Access ACC76 - a new temporary access from Mangreen Lane.
77. During the construction of SEP and/or DEP, it will be necessary to avoid the potential for conflict with National Grid traffic on National Grid's existing access from Mangreen Lane (access ACC73).
78. To achieve this, one of the following traffic management strategies would be implemented:
- A one-way system with access/egress via ACC76 and/or ACC73;
 - Access and egress via ACC73 or ACC76; or
 - Access and egress via ACC74.
79. At the time of drafting, it is unclear if access from the quarry ACC74 would be possible as there maybe ongoing restoration works which could conflict. However, should the restoration works at the quarry be complete, SEP and/or DEP construction traffic could potentially use access ACC74.
80. Upon completion of the construction works, operational access to the onshore substation would be via the existing National Grid access (ACC73).
81. To construct each of the accesses and crossings, temporary traffic management would be implemented to maintain highway safety and to ensure minimal delays to existing road users. Prior to the commencement of the relevant part of the construction works, details of traffic management at accesses and crossings would be developed by the CTMPCo in liaison with the highway authorities.

4.5 Access Management Measures

82. **Section 24.6.1** of ES **Chapter 24 Traffic and Transport** (document reference 6.1.24) assessed the impact of increases in construction traffic upon Driver Delay - Highway Constraints. The assessment for SEP or DEP in Isolation and SEP and DEP identified 43 links within the TTSA of constrained width which will prevent two vehicles from passing, potentially impacting on driver delay.
83. **Section 24.6.1** of ES **Chapter 24 Traffic and Transport** (document reference 6.1.24) set out a range of mitigation measures that could be adopted including:
- Road/ junction widening;
 - Formalising existing informal passing places; or
 - Using mobile traffic management, such as:
 - An escort vehicle to guide HGVs along roads and past oncoming traffic;
 - 'Stop-works' signage to hold traffic back (for up to two minutes in any 15 minutes) whilst HGVs travel along routes; or
 - 'Temporary obstruction' signage to hold traffic (for up to 15 minutes with a subsequent gap of at least one hour) whilst HGVs travel along routes.

84. It is proposed that prior to the commencement of the relevant part of the construction works, the CTMPCo would formalise and agree the measures to be adopted for each road. The final choice of the measures would be agreed in liaison with NCC, the CTMPCo would also seek the views of the local community upon their preference for types and location of measures.
85. Three other wind farm projects (Hornsea Project Three, Norfolk Vanguard and Norfolk Boreas) are also proposing to implement temporary measures (such as passing places) along some of the roads that would be used by SEP and/or DEP. These projects are due to commence 2023 and as such, there may be the potential that these improvements would complement (or replace) the access management measures for SEP and/or DEP.
86. To avoid abortive works and minimise delays to the public, the CTMPCo will engage with Hornsea Project Three, Norfolk Vanguard and Norfolk Boreas to establish if any of the measures that have been implemented can be retained for SEP and/or DEP.
87. Where road/junction widening or new/improved passing places are proposed, they would be contained within the public highway and the technical approvals for the designs will be submitted to and agreed with the highway authorities under Section 278 of the Highways Act (1980).
88. The technical approval process would include submission of finalised drawings, showing full details of the improvements, including drainage, lighting, signing, and standard construction details.
89. All road/junction widenings are proposed to be temporary and following completion of construction would be reinstated to their former state unless otherwise agreed with the highway authorities and the relevant landowner.
90. The technical approval documentation would also include a Stage 1 and 2 Road Safety Audit and a Road Safety Audit Response Report (on behalf of the designer's).

4.6 Cable Crossings

91. ES **Chapter 24 Traffic and Transport** (document reference 6.1.24) outlined that during the main cable installation works, the onshore cable corridor would be installed across 22 minor public roads using open cut trenching techniques. The remaining roads would be crossed using trenchless techniques, such as Horizontal Directional Drilling (HDD). **Annex C Road Crossing Schedule** details which roads for which it is proposed to use open cut trenching techniques and those where it is proposed to use trenchless techniques.
92. Due to the width of the majority of the roads to be open cut, it is proposed that they would be closed whilst the cables are installed for a period of up to two weeks.
93. To minimise the impact to existing road users the following measures are proposed:
 - A safe route would be maintained for pedestrians and cyclists through the works area;
 - Advanced signing would be implemented to assist drivers in finding alternative routes;

- The closures would be staggered, to ensure that nearby roads are not closed at the same time; and
- The CTMPCo and CLO would engage with affected local communities and stakeholders to provide advanced notification and identify if there may be periods which could be avoided.

94. Further specific mitigation was identified in ES **Chapter 24 Traffic and Transport** (document reference 6.1.24) to manage potential adverse driver delay impacts through the closure of Link 64 (Cherry Tree Road / Church Street). The assessment identified that this route was used by a school bus and as such, it is proposed that any closure of this road would be undertaken following consultation with the local bus operators and during the school holidays.
95. The PC would agree the final timing, diversion routes and method of reinstating the highway with NCC prior to the commencement of the relevant part of the construction works.

4.7 Junction Assessments

96. **Section 24.6.1** of ES **Chapter 24 Traffic and Transport** (document reference 6.1.24) identified 11 junctions as being potentially sensitive to changes in traffic. Capacity modelling of the proposed increase in peak construction traffic through these junctions has been undertaken.
97. This modelling has identified that there could be potentially significant driver delay impacts associated with SEP and DEP at the following junctions:
- Junction – 1 staggered priority junction of the A47, B1535 and Berry Lane to the east of Hockering/west of Honingham on the A47; and
 - Junction 7 – a three arm roundabout junction of the A47 and Norwich Road to the east of Honingham.
98. National Highways are however proposing to remove both these junctions as part of the A47 North Tuddenham to Easton improvement scheme. This scheme would remove these existing junctions providing new grade separated junctions on the A47. The improvement works are proposed to be complete by 2024/2025 and should therefore be in place prior to the commencement of SEP and DEP (scheduled to start in 2025 at the earliest).
99. However, the scheme is currently subject to Judicial Review and as such there is uncertainty regarding the status and likely completion date. Should the improvement works not go ahead, or not be implemented prior to the commencement of construction of SEP and DEP, the following mitigation strategy is proposed.
100. The CTMPCo will commission revised junction capacity modelling utilising refined construction parameters from the PC as well as latest surveys of background traffic and forecasts for cumulative traffic. This modelling would be submitted to National Highways, who would be requested to advise if they consider mitigation measures would be required.
101. Should National Highways identify the requirement for further mitigation, demand management measures would be proposed to ensure impacts are not significant. Potential mitigation measures could include car-sharing, spreading of arrival/finish

times, etc.

4.8 Road Safety

4.8.1 Road Safety Mitigation

102. **Section 24.6.1** of ES **Chapter 24 Traffic and Transport** (document reference 6.1.24) identified potentially significant road safety impacts associated with an increase in construction traffic (SEP or DEP in Isolation and SEP and DEP) through the collision cluster site 33 (within the proximity of a layby on the A47, southeast of King’s Lynn).
103. To reduce the impact of SEP and DEP vehicle trips through collision cluster site 33 the ES sets out mitigation measures to provide ‘Slow Down’, ‘Layby Ahead’ and ‘Vehicles Turning’ signage to make drivers aware of the potential for queuing and turning traffic in this location.
104. Prior to the commencement of the relevant part of the construction works, mitigation measures would be developed by the CTMPCo in liaison with National Highways and outlined within the final CTMP.

4.8.2 Road Safety Measures - A47, Blind Lane, Taverham Road

105. During a meeting with National Highways (3 July 2021), National Highways identified existing concerns at the A47, Blind Lane and Taverham Road junction.
106. National Highways are proposing to replace this junction as part of the A47 North Tuddenham to Easton improvement scheme. This scheme would remove this existing junction and therefore address road safety concerns by providing a modern standard compliant layout. The improvement works are proposed to be complete by 2024/2025 and should therefore be in place prior to the commencement of SEP and DEP, which is scheduled to start in 2025 at the earliest.
107. However, the scheme is currently subject to Judicial Review and as such there is uncertainty regarding the status and likely completion date. Should the improvement works not go ahead, or not be implemented prior to the commencement of construction of SEP and DEP, the following mitigation strategy is proposed.
108. Prior to the commencement/completion of the works by National Highways, temporary road safety improvements to the junction of the A47, Blind Lane and Taverham Road was proposed by Hornsea Project Three to mitigate the potential impacts of their construction traffic. These works include the closure of Blind Lane and creation of a left in left out only junction at Taverham Road.
109. Should either the temporary works (proposed by Hornsea Project Three) or permanent work (proposed by National Highways) not be implemented prior to the commencement of construction of SEP and DEP, the Applicant has committed to implementing temporary road safety measures at this location.
110. The extent of temporary works proposed by the Applicant would mirror those proposed by Hornsea Project Three.

4.8.3 Enhanced Maintenance

111. **Section 24.6.1** of ES **Chapter 24 Traffic and Transport** (document reference

6.1.24) identified a number of collision clusters where reduced visibility due to overgrown vegetation may have been a contributory factor to collisions.

112. Whilst the impact of SEP and DEP traffic at these locations was not considered to result in a road safety material impact, the following embedded mitigation measures are proposed to assist the highway authorities in their statutory duties to maintain the public highway:

- The CTMPCo would undertake regular inspections and clearance of overgrown vegetation in the vicinity of all SEP and DEP accesses and crossing locations.
- The CTMPCo would undertake regular inspections of identified collision cluster sites and report any safety critical maintenance issues to the relevant highway authority.
- Drivers would be requested through the induction process (**Section 2.3.4**) to report any road safety concerns in relation to the public highway, such as:
 - Reduced visibility due to overgrown vegetation;
 - Missing or damaged safety critical signs; and
 - Damage to the highway surface, etc.
- The CTMPCo would report any identified road safety issues to the relevant highway authorities.

4.9 Parking and Loading

113. Appropriate loading/unloading and parking areas for construction vehicles would be designated within the construction sites to avoid the need for parking or waiting on the highway. The planning of deliveries via the booking system would assist the CTMPCo to allocate sufficient space to accommodate the planned number of deliveries.

4.10 Traffic Incident Management Plan (TIMP)

114. To reduce the potential for construction traffic to have an adverse impact upon the highway network during planned and unplanned events, the measures set out in **Table 4-1** would be adopted.

Table 4-1: TIMP Measures Adopted During Events

Measure	Rationale
Managing traffic demand during major events that impact on the highway (e.g. bike races, parades, etc.) and around public holidays.	The CLO and CTMPCo will liaise with local stakeholders to understand when major events may occur. To ensure there are limited HGV trips during planned major events, the CTMPCo will undertake advanced planning to reschedule activities and stockpile of materials in advance.
Managing traffic demand during major incidents such as accidents on the highway.	The CTMPCo will monitor traffic conditions. Should the CTMPCo become aware of an incident then the Contractor will liaise directly with suppliers to suspend HGV deliveries along affected routes where required.
Incidents involving contractor HGV traffic blocking the	The contractor and their suppliers' fleets will have arrangements with recovery companies to allow breakdowns and accidents to be

Measure	Rationale
highway, such as, breakdowns, accidents, etc.	cleared as quickly as possible. All breakdowns and accidents will be reported to the TCo.
Managing traffic during intensive harvesting campaigns, etc.	The CLO and CTMPCo will liaise with local farmers to understand when intensive harvesting campaigns may occur. To ensure there are limited HGV trips during these periods, the CTMPCo will undertake advanced planning to reschedule activities and stockpile of materials in advance.

4.11 Cumulative Traffic

115. ES **Chapter 24 Traffic and Transport** (document reference 6.1.24) outlined the potential for cumulative impacts between SEP and DEP construction traffic and associated with the following projects:

- Wind farm Schemes:
 - Norfolk Vanguard (NV) - an offshore wind farm;
 - Hornsea Project Three (HP3) - an offshore wind farm; and
 - Norfolk Boreas - an offshore wind farm).
- Highway Schemes:
 - A47 North Tuddenham to Easton RIS - a highway improvement scheme;
 - A47 Blofield to North Burlingham RIS - a highway improvement scheme;
 - A47/A11 Thickthorn junction improvement RIS - a highway improvement scheme;
 - A47 Great Yarmouth - junction improvements; and
 - Norwich Western Link - a highway improvement scheme.

4.11.1 Wind Farm Schemes

116. **Section 24.7** of ES **Chapter 24 Traffic and Transport** (document reference 6.1.24) identified the potential for significant cumulative amenity impacts between SEP and DEP and HP3 and NV along links 90, 131 and 143.

117. The cumulative impact assessment presented within ES **Chapter 24: Traffic and Transport** (document reference 6.1.24) was informed by a worst-case scenario that assessed the impact of peak daily traffic flows from SEP and DEP and HP3 and NV overlapping.

118. It is currently understood that HP3 and NV will commence construction in 2023, as such the majority of work may be complete prior to the commencement of SEP and DEP (scheduled for 2025 at the earliest). Furthermore, the nature of the construction of wind farm schemes is that the peak period is typically short and associated with mobilisation activities) with lower average flows thereafter.

119. It is therefore likely that there will be no overlap of construction phases, or peak construction traffic movements. Notwithstanding, for links 90, 131 and 143 it would be proposed to ensure that cumulative traffic flows from SEP and DEP and HP3 and NV do not exceed those peak levels assessed as not leading to significant impacts

for SEP and DEP in ES **Chapter 24 Traffic and Transport** (document reference 6.1.24) and outlined within **Annex A Peak Vehicle Movements Per Link** of this OCTMP.

- 120. To ensure compliance with the traffic flows outlined in **Annex A Peak Vehicle Movements Per Link**, the CTMPCo will liaise with HP3 and NV to establish their potential forward programme for deliveries via these links. Where potential exceedances of the caps are identified, the CTMPCo for SEP and DEP will reschedule deliveries to ensure the cumulative caps are not exceeded.

4.11.2 Highway Schemes

- 121. With regards to the Highway Schemes, due to uncertainties regarding the timings of the start of construction (of these schemes), it was agreed with NCC and National Highways (NH) that potential cumulative impacts between the construction phases of the highway schemes and SEP and DEP would be managed through the respective CTMPs.
- 122. It is therefore proposed, that should the finalised construction programmes for the highway schemes highlight a potential overlap, the CTMPCo will engage with the relevant highway authorities to agree mitigation measures where appropriate. Mitigation measures could include for example, the respective projects committing to a programme of works that ensure peak traffic movements do not overlap.

4.12 Traffic Sensitive Streets

- 123. Applying their statutory powers, NCC has designated a number of routes subject to high traffic flows as ‘Traffic Sensitive Streets’. A number of criteria can be applied to identify a Traffic Sensitive Street, as set out in Section 64 of the New Roads and Street Works Act 1991 (Department for Transport 1991). The designation is not necessarily an indication of the level of congestion experienced by a route, it is more a general indication of the significance and volume of traffic using a route and therefore an indicator of the likely disruption that could be caused by roadworks
- 124. NCC have reviewed their street gazetteer and identified a total of 59 links (streets) within the TTSA that are considered to be potentially sensitive to the impacts of additional traffic (including those routes that that experience increases in traffic during seasonal periods).
- 125. ES **Chapter 24 Traffic and Transport** (document reference 6.1.24) contains an assessment of the impacts of the SEP and DEP traffic demand on the designated Traffic Sensitive Streets and has identified the links that require mitigation. **Table 4-2** details these routes and the proposed mitigation.

Table 4-2: Traffic Sensitive Links - Mitigation

Link ID	Link Description	Mitigation
9	A149 - The Street	HGV flows along the A149 through Weybourne would be reduced to ensure peak daily HGV demand does not exceed the forecast average daily HGV demand. These reduced flows (via links 9 and 11) would also reduce flows via links 14 and 15
11	A149 from Weybourne to Weybourne Road	
14	B1436 - Felbrigg	
15	A140 - Roughton	

Link ID	Link Description	Mitigation
		(which provide the main route to links 9 and 11 from the east). These reduced HGV flows are reflected in Annex A Peak Vehicle Movements Per Link and would be managed through the measures outlined in Section 2.2 .
49	B1149 from Buxton Road to Shorthorn Road	HGV flows along the B1149 would be capped to ensure they do not exceed levels agreed by NCC for Norfolk Vanguard and Hornsea Project Three. These caps are reflected in Annex A Peak Vehicle Movements Per Link and would be managed through the measures outlined in Section 2.2 and 4.10 .
51	B1149 from B1145 to Buxton Road	
54	B1149 from Spink's Lane to B1145	
56	B1149 from B1354 to Spink's Lane	
59	B1149 from A148 to B1354	
72	A1270 from Reepham Road to Brewery Lane	For the construction of SEP and DEP concurrently, vehicle movements along these links would be capped to ensure that they do not exceed flows for SEP and DEP in isolation (where significant impacts are not forecast). These caps are reflected in Annex A Peak Vehicle Movements Per Link and would be managed through the measures outlined in Section 2.2 and 3.2 .
73	A1270 from Fir Covert Road to Reepham Road	
79	A1067 from Marl Hill Road to A1270	
98	B1108 from Landlow Lane to B1108	

4.13 Highway Condition Surveys

126. Highway condition surveys would be undertaken by the CTMPCo prior to the commencement of the relevant part of the construction works and after the substantial completion of construction works. The surveys would include all roads and verges within the TTSA area that are not specifically designated for HGV movements, i.e. excluding all A roads. Any damage to the existing highway network as a consequence of SEP and DEP would be repaired by the PC or a financial contribution made to NCC to cover the cost of remedial works.
127. The survey would most likely comprise of a Coarse Visual Inspection survey (in accordance with the UK Pavement Management System standard). Prior to the commencement of the relevant part of the construction works the extent and scope of surveys would be agreed between the CTMPCo and NCC and outlined within the final CTMP.
128. In addition to undertaking surveys prior to, and on completion of the construction works, the PC would also undertake regular inspections of the highway network to identify any emerging issues (such as damage to verges or potholes forming). The PC would be assisted in this function by the CLO who would feedback any local highway condition issues from their community engagement.
129. Where emerging issues are identified as a result of SEP and DEP construction traffic, the PC would notify NCC and either repair the issue or ask NCC to undertake the repairs (with costs being recharged to the PC).

5 Monitoring, Enforcement and Action Plan

5.1 Introduction

130. The following section sets out how the targets and measures contained within this OCTMP would be monitored to ensure compliance.

5.2 Monitoring

5.2.1 Community Liaison

131. The Applicant would appoint a CLO who would be the first point of contact for all concerns raised. Contact details would be circulated to local communities and stored at community hubs (such as town halls and libraries) for reference.
132. In accordance with the requirements of 'Safety at Street Works and Road Works: A Code of Practice' (Department for Transport 2013), signs would also be erected at road works with the relevant contact number clearly displayed for public enquiries.
133. All enquiries would be recorded and responded to within seven working days. The enquirer would receive a written response detailing what action (if necessary) has been taken.

5.2.2 Baseline Traffic Validation

134. The assessment of driver delay (capacity) presented within ES **Chapter 24 Traffic and Transport** (document reference 6.1.24) has been informed by comparing changes between forecast 2025 background traffic flows and SEP and DEP construction traffic demand.
135. As a result of the Covid-19 pandemic and uncertainties regarding whether forecast 2025 background traffic flows would be representative of 'new normal' future traffic flows, NCC requested that the CTMP include a clause that permits further assessment of network capacity constraints (post consent) if baseline traffic conditions are evidenced to have materially increased from those presented within the DCO application.
136. In preparing the final CTMP, the CTMPCo would request NCC to confirm if they consider traffic conditions have materially changed and if so, provide evidence from their county wide traffic survey monitoring sites of these changes.
137. If a material change is evidenced by NCC, the CTMPCo would then compare these surveys to the forecasts contained within ES **Chapter 24 Traffic and Transport** (document reference 6.1.24). If a material increase in background traffic flows is noted, the driver delay impact assessment presented in ES **Chapter 24 Traffic and Transport** (document reference 6.1.24) would be revisited to understand if the assessment conclusions would be materially impacted.
138. In the event that a material impact is identified, the CTMPCo would develop a package of mitigation measures (in liaison with NCC) to ensure impacts are not significant.

5.2.3 HGV Numbers

139. To ensure compliance with the assessed daily HGV trips (outlined in **Section 2.3.1** of this document), the CTMPCo would operate a booking system for all deliveries.

The booking system would be continuously monitored (by the CTMPCo) to ensure the assessed number of trips are adhered to.

5.2.4 HGV Routing

140. The CTMPCo would implement a system to help the public distinguish HGV construction vehicles associated with SEP and DEP from other traffic on the network. Each vehicle would be required to display a unique identifier within the window of the cab (a recognisable logo) that would allow members of the public to report any concerns such as driver behaviour or the use of unapproved routes via a publicised telephone contact number.
141. CTMPCo would also ensure that weighting is given to the selection of suppliers with vehicle tracking software. Vehicle tracking software, together with delivery records would serve to augment the unique identifier to allow the CTMPCo to respond to any complaints and provide a complete evidence base.

5.2.5 Employee Mode Share

142. The CTMPCo would require all employees and visitors to sign in and out. This process will capture the employee's method of travel.

5.2.6 Road Safety

143. The CTMPCo would operate a 'near miss' reporting system for all highways incidents. The CTMPCo would ensure that all accidents and near misses are recorded within this system and that drivers are reminded to report all issues through inductions. Any accidents or near misses would be recorded, investigated, and reported to the highway authorities by the CTMPCo.
144. The CTMPCo would retain records of all incidents and submit to the highway authorities upon request. If emerging issues are identified, the CTMPCo would initiate discussions with stakeholders to promote a 'Zero Harm Culture'.

5.2.7 Monitoring Reports

145. Data recorded from the monitoring processes outlined above would be drawn together by the CTMPCo to produce a monthly monitoring report. The monthly monitoring report will be issued to the highway authorities each month.
146. In compiling the monitoring report, the CTMPCo would be able to identify effective/ineffective measures and the requirement for any remedial action to achieve the agreed targets. A typical structure for the monitoring report would be as follows:
 - **Introduction and Background** – this would provide detail with regards to the types of works being undertaken and number of construction workers;
 - **Results of Surveys and Monitoring** – the CTMPCo would collate the results of surveys and monitoring that have been undertaken. Where appropriate, the results of the surveys undertaken would be compared to the targets defined in the OCTMP. Data obtained from the surveys would be included as an appendix;

- **Achievements** – this would include the work undertaken over the previous period with evidence and examples;
- **Specific Measures** – this would detail how all measures from the CTMP have been implemented;
- **Summary** – the CTMPCo would detail whether the CTMP is on track to meet its targets and if not, why not; and
- **Future Plan** – this would detail the CTMP for the next period to include any specific outcomes or desired results with any additional measures that are to be included to remediate action.

5.3 Enforcement

147. To ensure that the final CTMP is effectively enforced, it is important to define what would constitute a breach. The following actions would constitute a breach of the CTMP, whereby corrective measures would be required:
- Exceedance of target daily vehicle numbers;
 - Construction workers overspill parking on the public highway;
 - Construction traffic operating outside of agreed hours;
 - Construction traffic not adhering to the agreed routes/times; or
 - Construction traffic being driven inappropriately, i.e. in contravention of the Highway Code.
148. On receipt of a report of a potential breach, the CTMPCo would investigate the circumstances and compile a report for the relevant highway authority as soon as reasonably practicable. The report would outline the outcome of the investigation and what corrective action (as necessary) has been implemented.
149. If the breach is found to be material, the CTMPCo would take appropriate action within the jurisdiction of the contract and report back to the relevant highway authority.
150. Individual employee breaches would be addressed through UK employment law whereby the process outlined above will form the basis for disciplinary proceedings.

5.4 Action Plan

151. The action plan set out in **Table 5-1** summarises the commitments and measures that will be implemented by the Applicant, PC and CTMPCo.
152. **Table 5-1** also provides an indicative timescale for the implementation of each of the measures. The exact details and associated timescales would be established in consultation with the highway authorities as part of the preparation of the final CTMP.

Table 5-1: OCTMP Action Plan

Measure ID	Measure	Responsibility	Indicative Timescale
M001	Appointment of a CLO.	The Applicant	Prior to the commencement

Measure ID	Measure	Responsibility	Indicative Timescale
			of the relevant part of the construction works.
M002	Appointment of a CTMPCo.	PC	Prior to the commencement of the relevant part of the construction works.
M003	Obtain technical approval for construction of accesses and crossings.	The Applicant	Prior to the commencement of the relevant part of the construction works.
M004	Obtain technical approval for construction of road widening, passing places, etc.	The Applicant	Prior to the commencement of the relevant part of the construction works.
M005	Implement direction signing.	CTMPCo	Prior to the commencement of the relevant part of the construction works.
M006	Agree timing, diversion routes and reinstatement details for cable crossings.	CTMPCo	Prior to the commencement of the relevant part of the construction works.
M007	Evaluate the potential for cumulative impacts and where necessary agree mitigation measures.	CTMPCo	Prior to the commencement of the relevant part of the construction works.
M008	Provide details of peak traffic flows through sensitive junctions 1 and 7 and where necessary agree mitigation measures.	CTMPCo	Prior to the commencement of the relevant part of the construction works.
M009	Agree and implement road safety improvements at cluster site 33.	CTMPCo	Prior to the commencement of the relevant part of the construction works.
M010	Establish monitoring systems: <ul style="list-style-type: none"> • Delivery booking system; • Highway condition; • Unique vehicle identifier system; and • Telephone reporting system. 	CTMPCo	Prior to the commencement of the relevant part of the construction works.
M011	Agree scope of and undertake highway pre-work condition surveys.	CTMPCo	Prior to the commencement of the relevant part of the construction works.
M012	Agree and implement measures for each access to control the deposition of detritus on the public highway.	CTMPCo	Prior to the commencement of the relevant part of the construction works.
M013	Inspect the highway for detritus and request regular cleansing as required.	CTMPCo	Ongoing throughout construction.
M014	Undertake regular liaison with community and stakeholders	CTMPCo and CLO	Ongoing throughout construction.
M015	Monitoring of CTMP measures: HGV trips; Accidents and near misses; Employee mode share; and	CTMPCo	Ongoing throughout construction.

Measure ID	Measure	Responsibility	Indicative Timescale
	Complaints.		
M016	Produce monthly monitoring reports.	CTMPCo	Ongoing throughout construction.
M017	Updated condition surveys and agree extent of any remedial works.	CTMPCo	Following completion of construction.

References

Highways Act 1980. Available at: https://www.legislation.gov.uk/ukpga/1980/66/contents (Accessed: 12 May 2022).
New Roads and Street Works Act 1991. Available at: https://www.legislation.gov.uk/ukpga/1991/22/contents (accessed: 12 May 2022).
Road Traffic Regulation Act 1984. Available at: https://www.legislation.gov.uk/ukpga/1984/27/contents (accessed: 12 May 2022).
Safety at Street Works and Road Works: A Code of Practice. Available at: https://www.gov.uk/government/publications/safety-at-street-works-and-road-works (accessed: 12 May 2022).

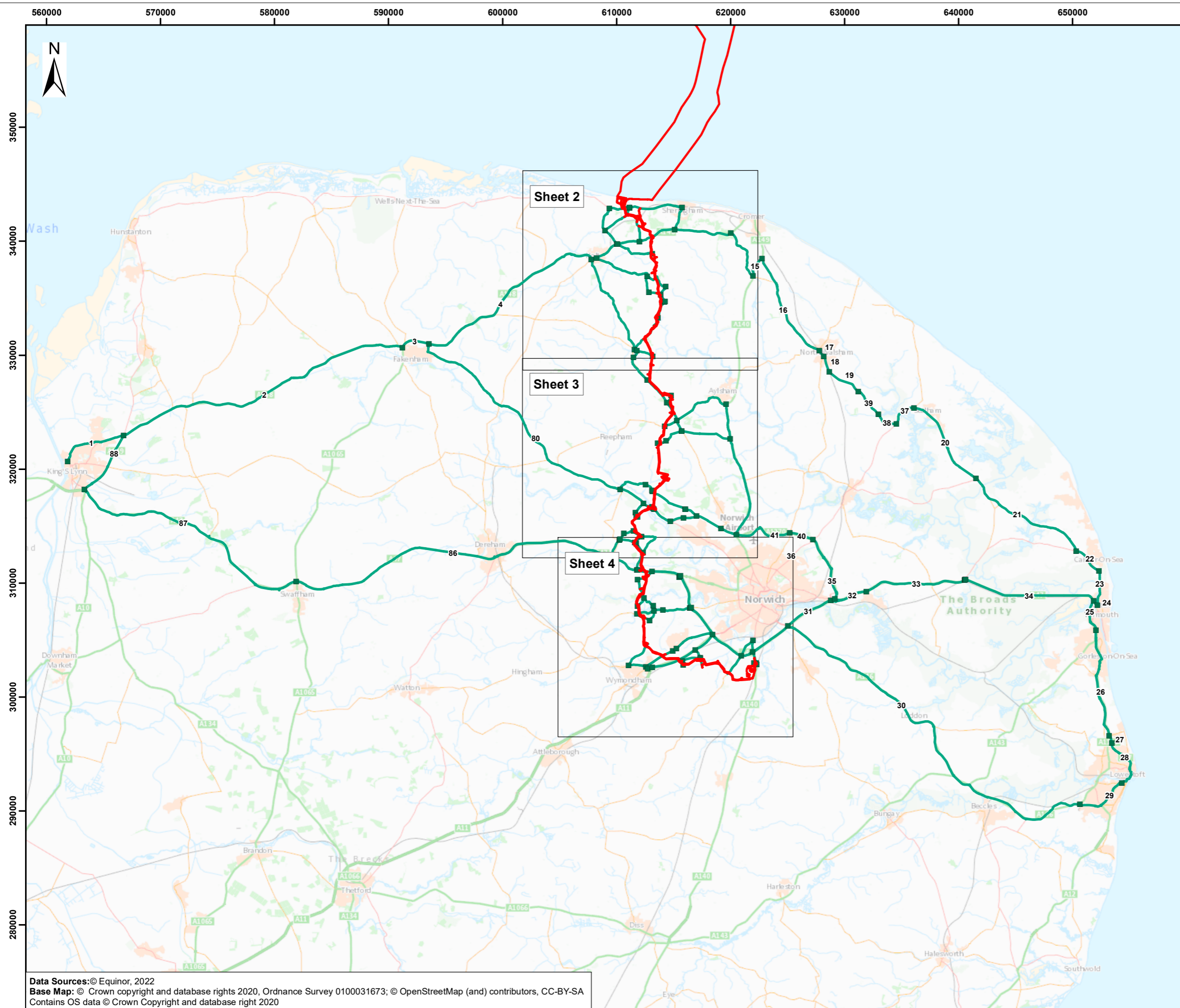

Sheringham Shoal and Dudgeon Extension Projects

Title:
Figure 1 HGV Routes
Sheet 1 of 4

Document:
DCO Document
Construction Traffic Management Plan

Application Doc. no.: 9.16

Legend:
 DCO Boundary
 Links used by HGV Traffic



Coordinate Reference System: British National Grid
 Transformation WGS84: OSGB_1936_To_WGS_1984_7

0 4 8 12 16 20 km
 0 4 8 12 Miles

Scale: 1:320,000 Scale at size: A3

Equinor Doc. no.: C282-RH-Z-GA-00126
 RHDHV Doc. no.: PB8164-RHD-ZZ-ON-DR-Z-0172

REV	DATE	STATUS	DRW	CHK	APR
D	02/05/2023	Fourth Issue	DE	ST	SM
C	20/02/2023	Third Issue	DE	ST	SM
B	22/07/2022	Second Issue	GC	ST	SM
A	27/04/2022	First Issue	AZ	ST	SM

Data Sources: © Equinor, 2022
 Base Map: © Crown copyright and database rights 2020, Ordnance Survey 0100031673; © OpenStreetMap (and) contributors, CC-BY-SA
 Contains OS data © Crown Copyright and database right 2020



605000

610000

615000

620000

345000

340000

335000

330000

Sheringham Shoal and Dudgeon Extension Projects

Title:

Figure 1 HGV Routes
Sheet 2 of 4

Document:

DCO Document
Construction Traffic Management Plan

Application Doc. no.: 9.16

Legend:

 Order Limits

 Links used by HGV Traffic

Data Sources: © Equinor, 2022
Base Map: © Crown copyright and database rights 2020,
Ordnance Survey 0100031673; © OpenStreetMap (and)
contributors, CC-BY-SA

Coordinate Reference System: British National Grid
Transformation WGS84: OSGB_1936_To_WGS_1984_7

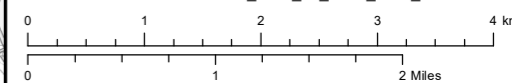

Scale: 1:65,000

Scale at size: A3

Equinor Doc. no.: C282-RH-Z-GA-00126

RHDHV Doc. no.: PB8164-RHD-ZZ-ON-DR-Z-0171

REV	DATE	STATUS	DRW	CHK	APR
D	02/05/2023	Fourth Issue	DE	ST	SM
C	12/02/2023	Third Issue	GC	ST	SM
B	22/07/2022	Second Issue	GC	ST	SM
A	22/04/2022	First Issue	AZ	ST	SM

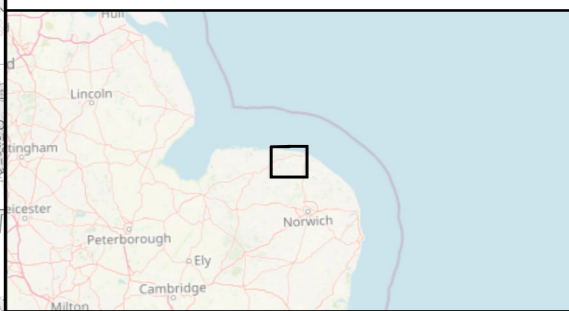
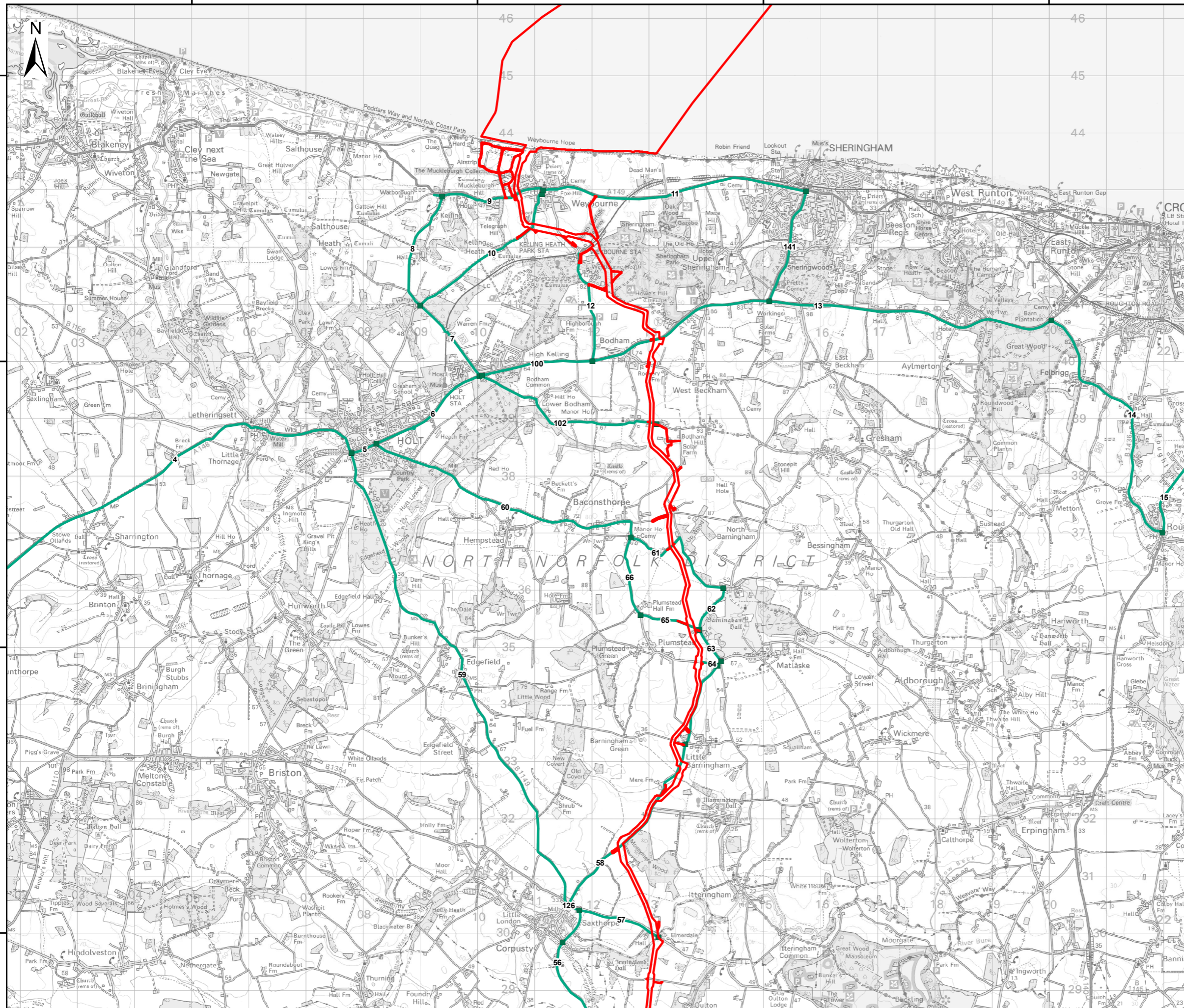

605000

610000

615000

620000

Sheringham Shoal and Dudgeon Extension Projects

Title:

Figure 1 HGV Routes

Sheet 3 of 4

Document:

DCO Document
Construction Traffic Management Plan

Application Doc. no.: 9.16

Legend:

 Order Limits

 Links used by HGV Traffic

Data Sources: © Equinor, 2022
Base Map: © Crown copyright and database rights 2020,
Ordnance Survey 0100031673; © OpenStreetMap (and)
contributors, CC-BY-SA



Coordinate Reference System: British National Grid
Transformation WGS84: OSGB_1936_To_WGS_1984_7

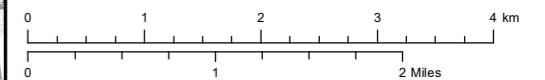

Scale: 1:65,000

Scale at size: A3

Equinor Doc. no.: C282-RH-Z-GA-00126

RHDHV Doc. no.: PB8164-RHD-ZZ-ON-DR-Z-0171

REV	DATE	STATUS	DRW	CHK	APR
D	02/05/2023	Fourth Issue	DE	ST	SM
C	12/02/2023	Third Issue	GC	ST	SM
B	22/07/2022	Second Issue	GC	ST	SM
A	22/04/2022	First Issue	AZ	ST	SM

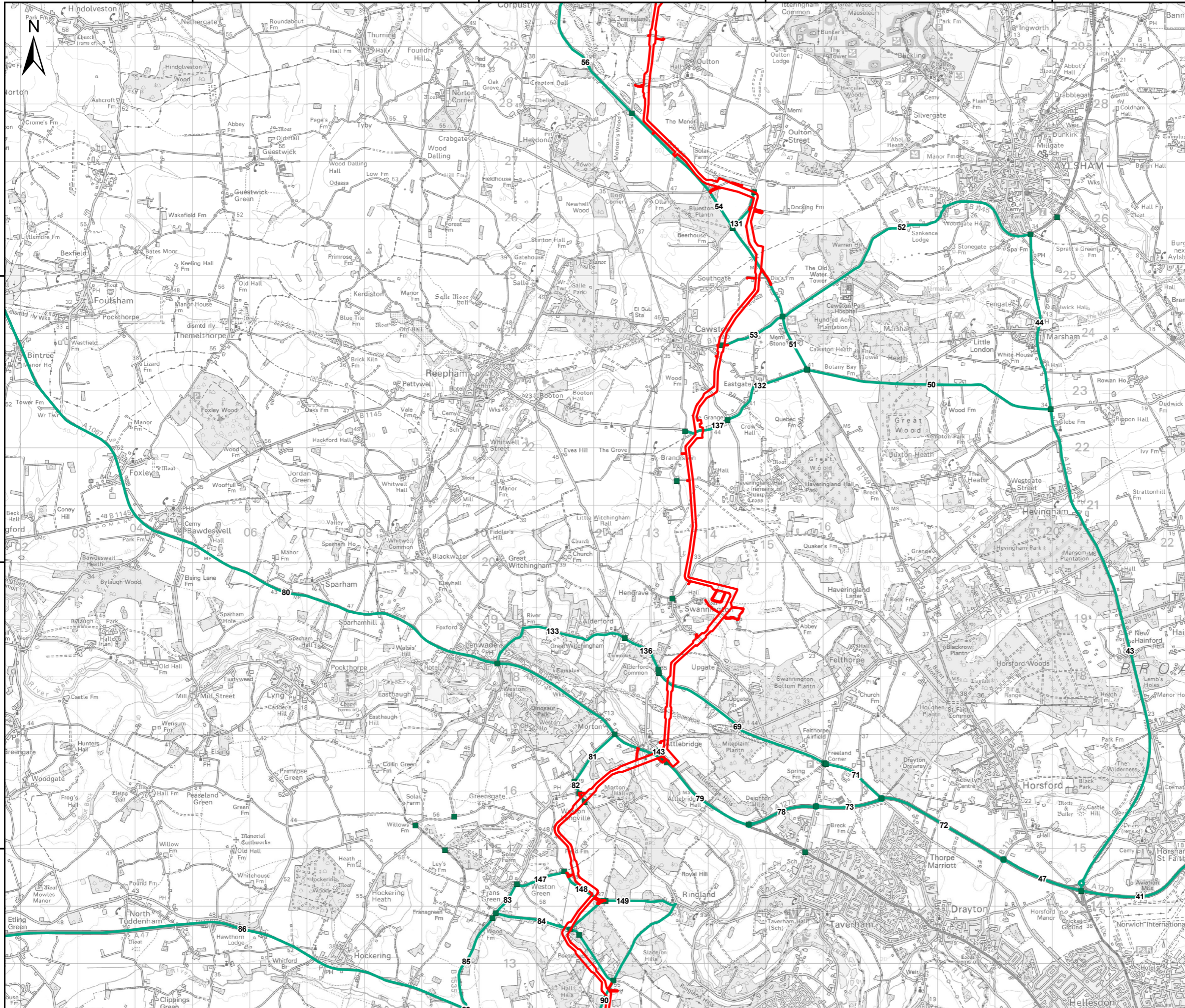

325000

320000

315000

605000 610000 615000 620000 625000

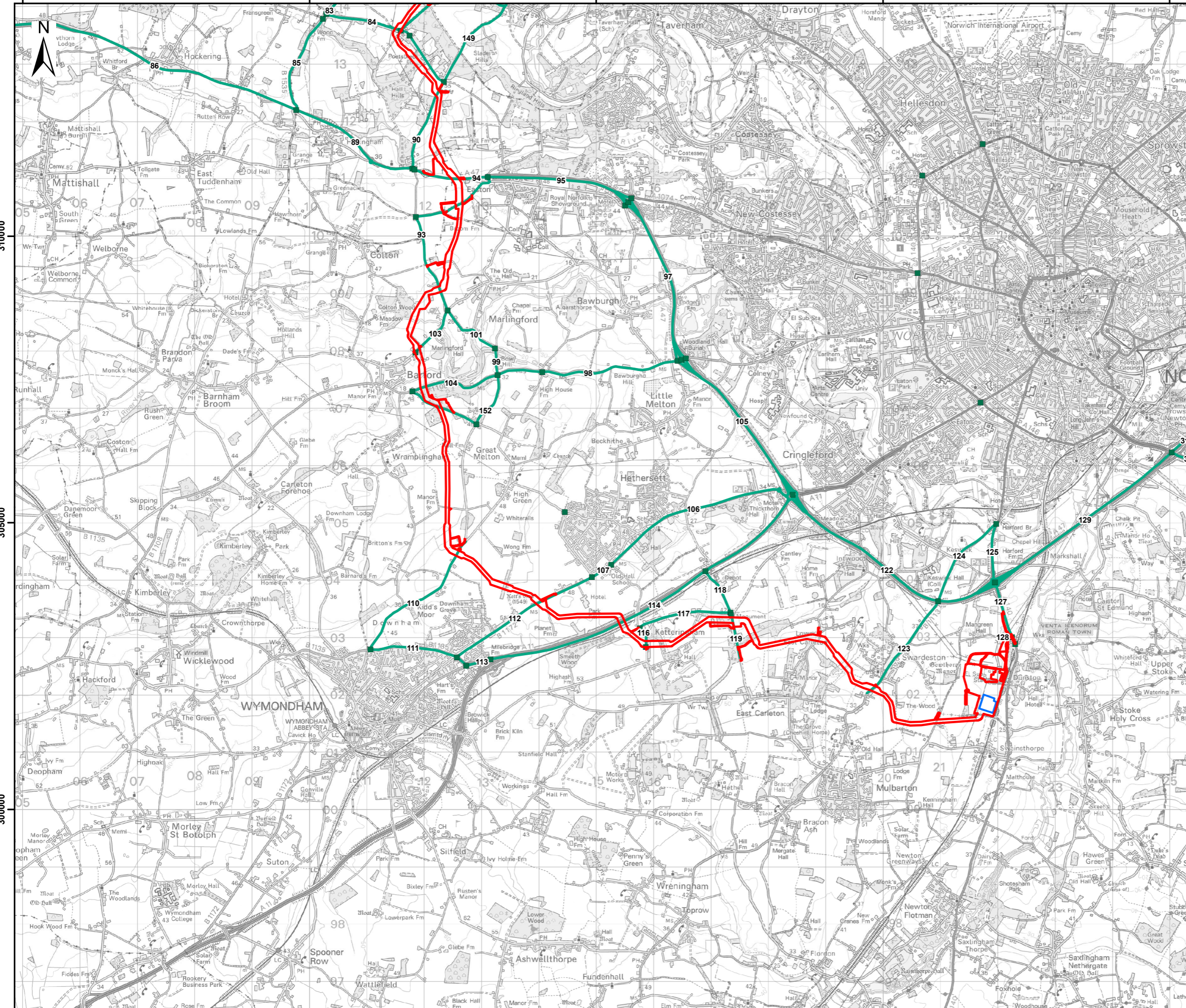

Sheringham Shoal and Dudgeon Extension Projects

Title: Figure 1 HGV Routes
Sheet 4 of 4

Document: DCO Document
Construction Traffic Management Plan

Application Doc. no.: 9.16

- Legend:
- Order Limits
 - Onshore Substation Site
 - Links used by HGV Traffic

Data Sources: © Equinor, 2022
Base Map: © Crown copyright and database rights 2020, Ordnance Survey 0100031673; © OpenStreetMap (and) contributors, CC-BY-SA



Coordinate Reference System: British National Grid
Transformation WGS84: OSGB_1936_To_WGS_1984_7

0 1 2 3 4 km
0 1 2 Miles

Scale: 1:65,000 Scale at size: A3

Equinor Doc. no.: C282-RH-Z-GA-00126
RHDHV Doc. no.: PB8164-RHD-ZZ-ON-DR-Z-0171

REV	DATE	STATUS	DRW	CHK	APR
D	02/05/2023	Fourth Issue	DE	ST	SM
C	12/02/2023	Third Issue	GC	ST	SM
B	22/07/2022	Second Issue	GC	ST	SM
A	22/04/2022	First Issue	AZ	ST	SM



Annex A

Table A1.1: Peak Vehicle Trips Per Link

Link ID	Link Description	Maximum Daily Vehicle Trips			
		SEP or DEP in Isolation		SEP and DEP	
		All vehicles	HGVs	All vehicles	HGVs
1	A1078 Low Road / A148 Grimston Road	673	595	851	743
2	A148 from A149 to A1065	375	269	481	340
3	A148 from A1065 to A1067	362	269	456	340
4	A148 from A1067 to B1149	331	242 (570)	371	262 (570)
5	A148 from B1149 to Hempstead Road	345	145 (570)	448	186 (570)
6	A148 from Hempstead Road to Bridge Road	252	133 (570)	324	169 (570)
7	Bridge Road	20	20	18	18
8	The Street	63	51	71	55
9	A149 - The Street	155	15	257	15
10	Holgate Hill / Holt Road	155	54	187	58
11	A149 from Weybourne to Weybourne Road	169	20	239	20
12	Station Road / Sandy Hill Lane / Gypsies' Lane	172	86	209	95
13	A148 from Gypsies' Lane to B1436	359	143 (570)	429	179 (570)
14	B1436 - Felbrigg	325	133	395	169
15	A140 - Roughton	221	133	291	169
16	A149 - North Walsham	160	133	203	169
17	A149 from B1145 to B1150	160	133	203	169
18	A149 from B1150 to Kidas Way	160	133	203	169
19	A149 from Kidas Way to Honning Road	160	133	203	169
20	A149 from B1159 to Station Road	153	133	194	169
21	A149 from Station Road to A1064	153	133	194	169
22	A149 from A1064 to Yarmouth Road	133	133	169	169
23	A149 from Yarmouth Road to B1141	133	133	169	169
24	A149 from B1141 to A47	548	548	668	668
25	A12 from A47 to Williams Adams Way	366	265	476	336
26	A12 from Williams Adams Way to B1385	319	265	411	336
27	A12 from B1385 to A1117	265	265	336	336
28	A12 from A1117 to Mill Road	265	265	336	336
29	A12 from Mill Road to B1384 / A1145 from B1384 to A146	320	320	401	401
30	A146 from A47 to A1145	772	320	1,024	401
31	A47 from A146 to A1042	709	320	932	401
32	A47 from A1042 to Cucumber Lane	587	475	762	603
33	A47 from Cucumber Lane to A1064	614	475	799	603
34	A47 from A1064 to A12	588	475	759	603

Link ID	Link Description	Maximum Daily Vehicle Trips			
		SEP or DEP in Isolation		SEP and DEP	
		All vehicles	HGVs	All vehicles	HGVs
35	A1270 from A1151 to A47	605	255	778	326
37	A149 from A1151 to B1159	153	133	194	169
38	A149 from The Street to A1151	160	133	203	169
39	A149 from Honing Road to The Street	160	133	203	169
40	A1270 from B1150 to A1151	675	255	872	326
41	A1270 from A140 to B1150	630	255	804	326
42	A140 from B1149 to A1042	764	0	880	0
43	A140 from Cawston Road to A1270	498	232	552	206
44	A140 from B1145 to Cawston Road	377	167	443	179
45	A140 from B1145 to Aylsham Road	235	0	296	0
46	A140 from Thorpe Market Road to Aylsham Road	312	0	396	0
47	A1270 from Drayton Lane to A140	789	228	1,035	283
48	Brewery Lane / B1149 from Brewery Lane to Shorthorn Road	308	0	372	0
49	B1149 from Buxton Road to Shorthorn Road	391	75 (289)	455	74 (289)
50	Buxton Road	80	80	79	79
51	B1149 from B1145 to Buxton Road	416	93 (289)	473	92 (289)
52	B1145 from B1149 to A140	193	167	212	179
53	B1145 from Old Friendship Lane to B1149	93	54 (239)	121	54 (239)
54	B1149 from Spink's Lane to B1145	555	238 (289)	594	212 (289)
56	B1149 from B1354 to Spink's Lane	536	232 (289)	575	207 (289)
57	B1354 east of B1149	95	37	95	50
58	Unnamed Road	289	156	371	148
59	B1149 from A148 to B1354	343	215 (289)	370	169 (289)
60	Hempstead Road / The Street	64	64	66	66
61	Church Lane / Unnamed Road	82	57	86	58
62	Unnamed Road	84	30	92	31
63	Unnamed Road	89	35	97	36
64	Church Street / Cherry Tree Road	52	27	53	27
65	Northfield Lane	5	5	5	5
66	Plumstead Road	38	38	39	39
67	Shorthorn Road	180	75	197	74
68	The Street / Taverham Road	106	0	125	0
69	Reepham Road	247	78	383	81
71	Reepham Road	163	36	265	35
72	A1270 from Reepham Road to Brewery Lane	442	110	442	110
73	A1270 from Fir Covert Road to Reepham Road	318	75	318	75

Link ID	Link Description	Maximum Daily Vehicle Trips			
		SEP or DEP in Isolation		SEP and DEP	
		All vehicles	HGVs	All vehicles	HGVs
74	Fir Covert Road	89	0	106	0
75	Fir Covert Road	150	0	197	0
76	A1067 from Beech Avenue to A140	206	0	289	0
77	A1067 from A1270 to Fir Covert Road	20	0	28	0
78	A1270 from A1067 to Fir Covert Road	257	75	340	81
79	A1067 from Marl Hill Road to A1270	419	129	419	129
80	A1067 from A148 to Marl Hill Road	231	128	279	139
81	Marl Hill Road	173	57	243	62
82	Ringland Lane / Morton Lane	107	57	153	62
83	Church Street / Church Farm Close / Woodforde Close / Honingham Road / Paddy's Lane	124	0	192	0
84	The Broadway / Unnamed Road	45	22	52	23
85	Wood Lane	218	68	311	97
86	A47 from A1065 to Berrys Lane	581	363	786	472
87	A47 from A10 to A1065	505	363	678	472
88	A149 from A148 to A47	363	363	478	472
89	A47 from Wood Lane to Taverham Road	608	363	830	472
90	Taverham Road	161	75 (75)	281	137 (137)
93	Unnamed Road / Dereham Road	322	159	410	165
94	A47 from Blind Lane to Dereham Road	615	363	774	472
95	A47 from Dereham Road to A1074	686	341	925	417
96	A1074 from A47 to A140	124	0	178	0
97	A47 from A1074 to B1108	625	341	846	417
98	B1108 from Landlow Lane to B1108	226	81	226	81
99	Bow Hill	134	45	165	45
100	A148 from Bridge Road to Gypsie's Lane	232	113 (570)	275	120 (570)
101	Church Road / Bow Hill	134	45	165	45
102	Unnamed Roads	31	17	31	17
103	Chapel Street	155	67	176	64
104	B1108 west of Bow Hill	191	81	275	95
105	A47 from B1108 to A11	800	361	1,121	471
106	B1172 from Ketteringham Lane to A47	172	64	222	91
107	B1172 from New Road to Ketteringham Lane	148	64	211	91
108	New Road	0	0	4	0
109	Hethersett Road	0	0	4	0
110	Melton Road / High Green	102	54	137	56

Link ID	Link Description	Maximum Daily Vehicle Trips			
		SEP or DEP in Isolation		SEP and DEP	
		All vehicles	HGVs	All vehicles	HGVs
111	B1135 from Melton Road to Norwich Common	62	54	69	56
112	B1172 from B1135 to New Road	148	64	203	91
113	B1135 from B1172 to A11	220	100	358	132
114	A11 from B1135 to A47	366	100	542	132
115	Ketteringham Lane	17	0	34	0
116	High Street	107	63	135	58
117	Low Street	90	63	110	58
118	Station Lane	221	94	282	99
119	Hethersett Road	220	93	270	96
121	A11 from A47 to A140	3	0	4	0
122	A47 from A11 to A140	691	353	943	463
123	B1113 south of the A47	115	67	104	56
124	B1113 from A47 to A140	115	67	104	56
125	A140 from A146 to A47	226	67	277	56
126	Aylsham Road	523	232	562	206
127	A140 south of the A47	476	189	756	287
128	Mangreen	411	189	667	287
129	A47 from A140 to A146	697	320	970	401
131	The Street	88	54 (54)	100	54 (54)
132	Buxton Road / Easton Way	142	34	135	34
133	Porter's Lane / Hall Road	54	46	61	46
136	Reepham Road from its junction with Hall Road to junction with Station Road	54	46	61	46
137	Unnamed Road, east of its junction with Grove Lane	242	127	254	115
138	Broad Lane / The Street	55	0	101	0
139	Unnamed road	111	0	153	0
141	A1082 Holway Road	169	69	219	93
143	Old Fakenham Road	261	77 (77)	285	77 (77)
144	Ringland Lane	5	0	10	0
146	Breck Road / Unnamed Road	51	0	69	0
147	Breck Road / Weston Green Road	37	19	39	20
148	Weston Road	135	67	178	79
149	Unnamed road	19	19	20	20
150	Unnamed Road	51	0	69	0
152	Burdock Lane / Landlow Lane	165	69	172	68
153	Rectory Road / Catbridge Lane	4	0	4	0

Link ID	Link Description	Maximum Daily Vehicle Trips			
		SEP or DEP in Isolation		SEP and DEP	
		All vehicles	HGVs	All vehicles	HGVs
Notes					
	Links where mitigation has been applied to reduce forecast SEP and/or DEP traffic flows.				
	Links where mitigation may be required to reduce cumulative traffic flows. Cumulative cap is presented in brackets.				
	Links where mitigation will be required to reduce forecast SEP and/or DEP traffic flows to mitigate noise impacts. Final values to be confirmed.				

Annex B Outline Access Designs



- NOTES**
1. Do not scale from this drawing, all dimensions are in metres unless noted otherwise.
 2. This drawing has been based upon Ordnance Survey Maps and Royal HaskoningDHV can not guarantee the accuracy of data.
 3. X-distance - the set back from the nearest edge of the carriageway from which the access will be taken
 4. Y-Distance - the SSD measured along the nearest edge of the carriageway to its intersection with the centreline of the access.
 5. All vegetation to be cleared/trimmed within identified visibility envelope and thereafter maintained in accordance with Norfolk County Council maintenance practices.

- KEY**
- EXISTING ARRANGEMENT
 - ORDER LIMITS
 - PROPOSED ACCESS BOUNDARY/ROAD MARKINGS
 - VISIBILITY SPLAY (SEE BELOW)

A148 BODHAM

Posted Speed Limit (PSL) (mph)	60
Measured 85 th percentile speed (mph)	50.4
Proposed temporary speed limit (mph)	30
Required Y-distance SSD for 85 th percentile speed (m)	160
Observable on-site measured Y-distance (m)	170 (E) > 200 (W)

- ◀ PROPOSED TEMPORARY ROAD SIGN
- FULL DEPTH CARRIAGEWAY CONSTRUCTION WITH BOUND SURFACE

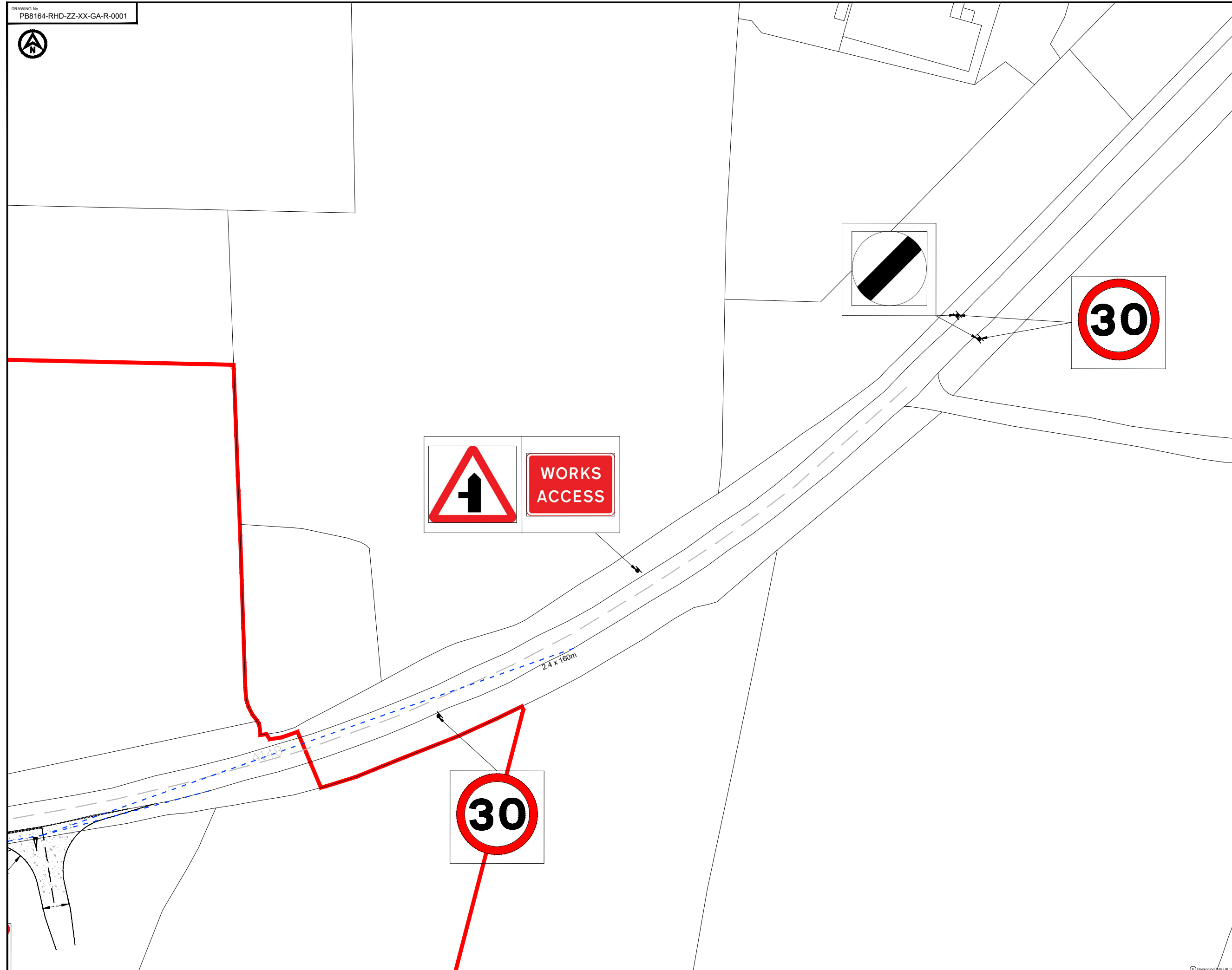

REV	DATE	DESCRIPTION	BY	CHK	APP
D1.0	31.08.21	FIRST ISSUE	SKT	SKT	ADR

REVISIONS

CLIENT

EQUINOR

PROJECT
DUDGEON & SHERINGHAM SHOAL
OFFSHORE WIND FARM
EXTENSIONS

TITLE
A148 BODHAM
DRAFT
ACC10 ACCESS DESIGN
(SHEET 1 OF 2)



DRAWN	CHECKED	APPROVED
SKT	SKT	ADR
DATE	SCALE AT A3	AUTOCAD REF.
31.08.2021	1:1000	

DRAWING No. PB8164-RHD-ZZ-XX-GA-R-0001	REVISION
CLIENT DWG No.	D1.0



- NOTES**
1. Do not scale from this drawing, all dimensions are in metres unless noted otherwise.
 2. This drawing has been based upon Ordnance Survey Maps and Royal HaskoningDHV can not guarantee the accuracy of data.
 3. X-distance - the set back from the nearest edge of the carriageway from which the access will be taken
 4. Y-Distance - the SSD measured along the nearest edge of the carriageway to its intersection with the centreline of the access.
 5. All vegetation to be cleared/trimmed within identified visibility envelope and thereafter maintained in accordance with Norfolk County Council maintenance practices.

- KEY**
- EXISTING ARRANGEMENT
 - ORDER LIMITS
 - PROPOSED ACCESS BOUNDARY/ROAD MARKINGS
 - VISIBILITY SPLAY (SEE BELOW)

A148 BODHAM

Posted Speed Limit (PSL) (mph)	60
Measured 85 th percentile speed (mph)	50.4
Proposed temporary speed limit (mph)	40
Required Y-distance SSD for 85 th percentile speed (m)	160
Observable on-site measured Y-distance (m)	170 (E) > 200 (W)

- ◀ PROPOSED TEMPORARY ROAD SIGN

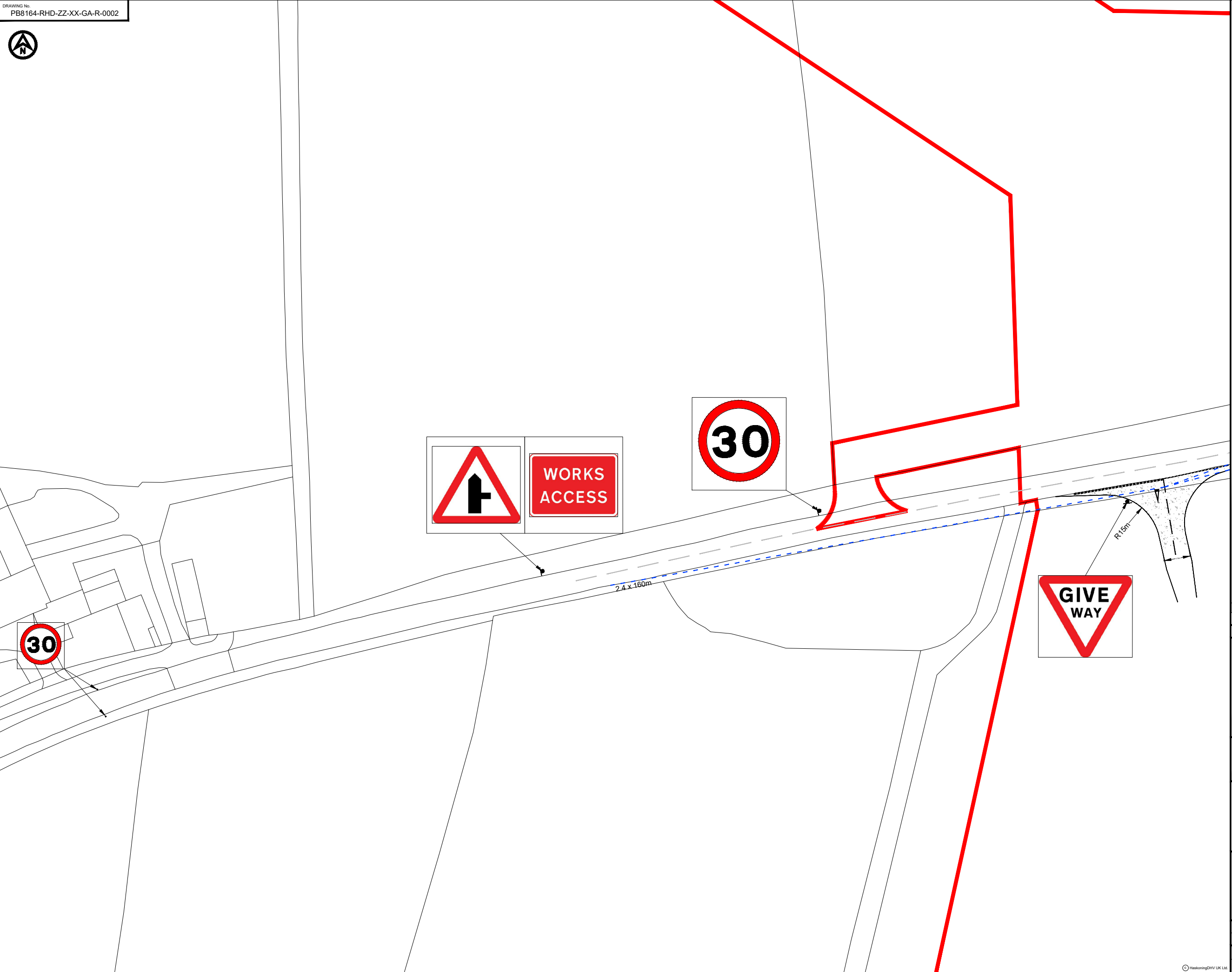
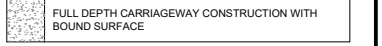

D1.0	31.08.21	FIRST ISSUE	SKT	SKT	ADR
REV	DATE	DESCRIPTION	BY	CHK	APP

REVISIONS

CLIENT

EQUINOR

PROJECT
DUDGEON & SHERINGHAM SHOAL
OFFSHORE WIND FARM
EXTENSIONS

TITLE
A148 BODHAM
DRAFT
ACC10 ACCESS DESIGN
(SHEET 2 OF 2)



DRAWN	SKT	CHECKED	SKT	APPROVED	ADR
DATE	31.08.2021	SCALE AT A3	1:1000	AUTOCAD REF.	

DRAWING No.	PB8164-RHD-ZZ-XX-GA-R-0002	REVISION	
CLIENT DWG No.			D1.0



NOTES
 1. Do not scale from this drawing, all dimensions are in metres unless noted otherwise.
 2. This drawing has been based upon Ordnance Survey Maps and Royal HaskoningDHV can not guarantee the accuracy of data.

KEY
 — EXISTING ARRANGEMENT
 — ORDER LIMITS
 — PROPOSED ACCESS BOUNDARY/ROAD MARKINGS

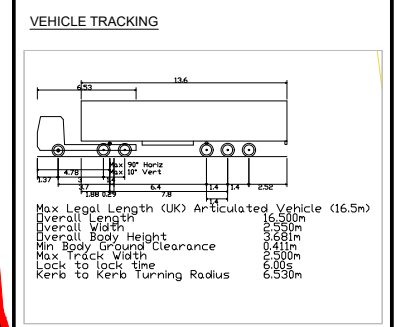

▨ VEHICLE BODY SWEEP PATH (FORWARD GEAR)
 — VEHICLE CHASSIS SWEEP PATH

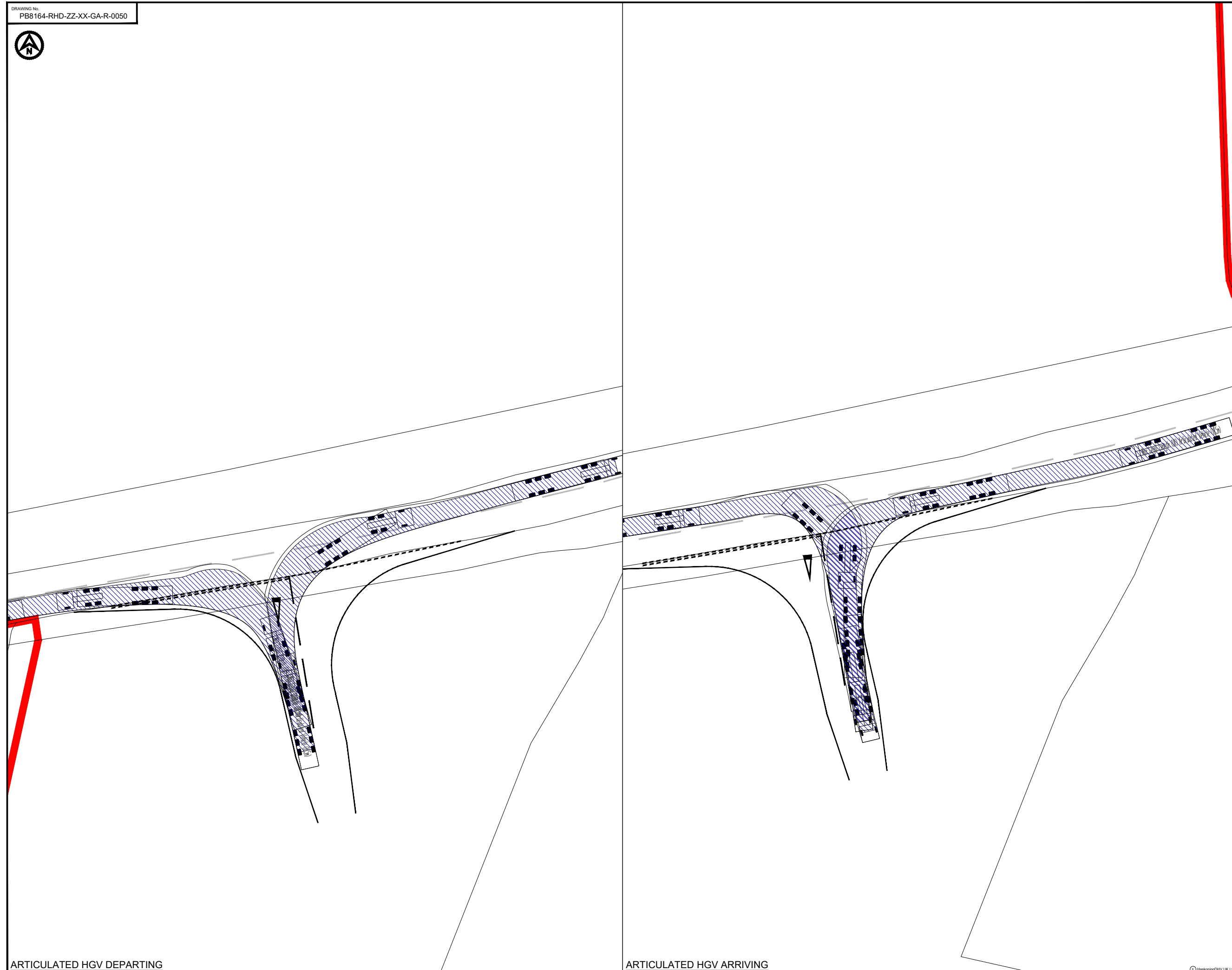

REV	DATE	DESCRIPTION	BY	CHK	APP
D1.0	31.08.21	FIRST ISSUE	SKT	SKT	ADR

REVISIONS

CLIENT

EQUINOR

PROJECT
 DUDGEON & SHERINGHAM SHOAL
 OFFSHORE WIND FARM
 EXTENSIONS

TITLE
 A140 BODHAM
 DRAFT
 ACC10 ACCESS DESIGN
 SWEEP PATH ANALYSIS



DRAWN	CHECKED	APPROVED
SKT	SKT	ADR
DATE	SCALE AT A3	AUTOCAD REF.
31.08.2021	1:500	
DRAWING No. PB8164-RHD-ZZ-XX-GA-R-0050	REVISION	
CLIENT DWG No.		D1.0

ARTICULATED HGV DEPARTING

ARTICULATED HGV ARRIVING

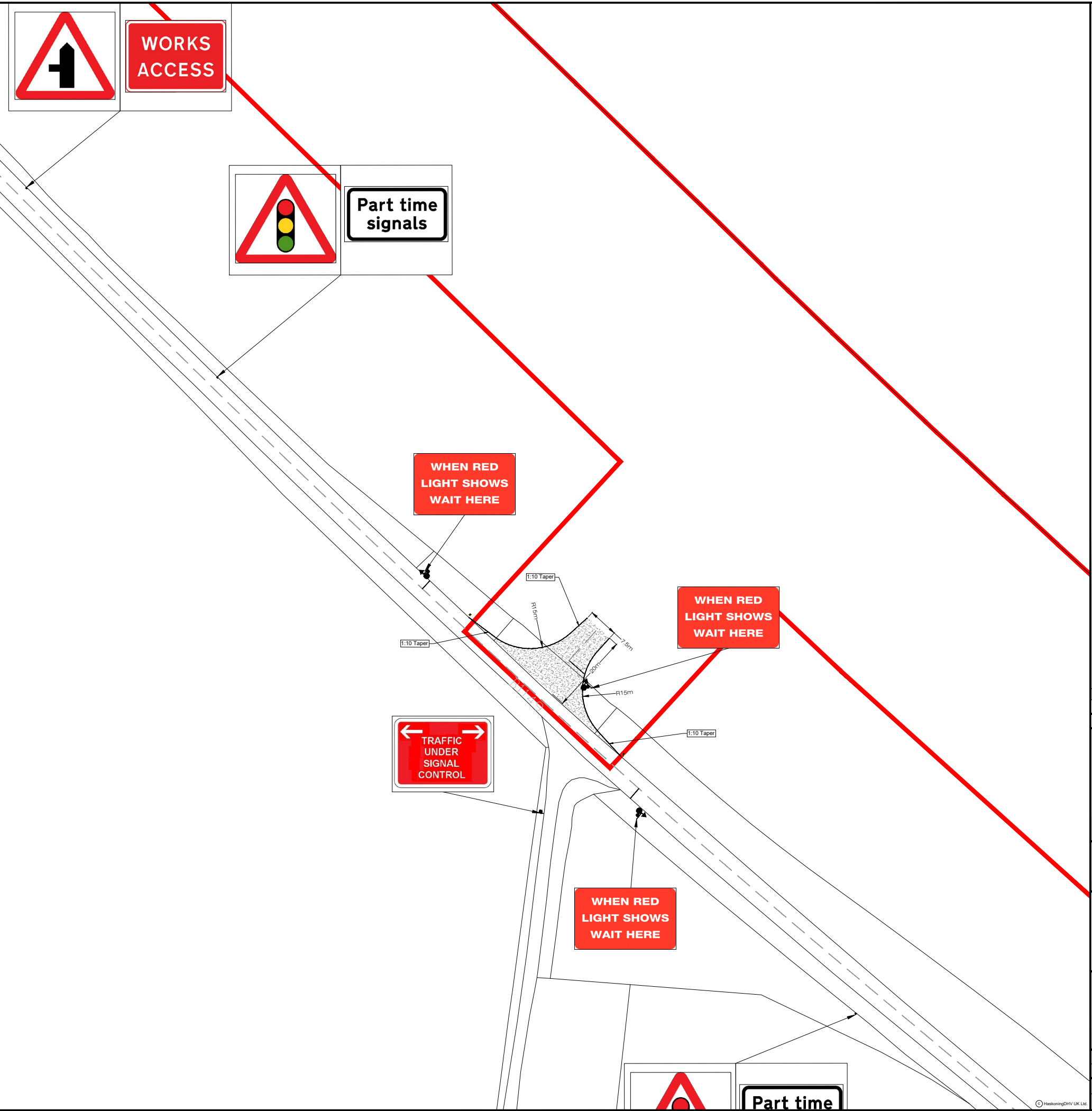

NOTES
 1. Do not scale from this drawing, all dimensions are in metres unless noted otherwise.
 2. This drawing has been based upon Ordnance Survey Maps and Royal HaskoningDHV can not guarantee the accuracy of data.

KEY
 — EXISTING ARRANGEMENT
 — ORDER LIMITS
 — PROPOSED ACCESS BOUNDARY/ROAD MARKINGS
 PROPOSED TEMPORARY ROAD SIGN
 PROPOSED TEMPORARY TRAFFIC LIGHT
 FULL DEPTH CARRIAGEWAY CONSTRUCTION WITH BOUND SURFACE

REV	DATE	DESCRIPTION	BY	CHK	APP
D1.0	17.06.22	FIRST ISSUE	JL	SKT	ADR

REVISIONS

CLIENT

EQUINOR

PROJECT
DUDGEON & SHERINGHAM SHOAL
OFFSHORE WIND FARM
EXTENSIONS

TITLE
B1149 OULTON
DRAFT
ACC25 ACCESS DESIGN
(SHEET 1 OF 2)



DRAWN	CHECKED	APPROVED
JL	SKT	ADR

DATE 17.06.2022 SCALE AT A3 1:1000 AUTOCAD REF.

DRAWING No. PB8164-RHD-ZZ-XX-GA-R-0003 REVISION

CLIENT DWG No. D1.0

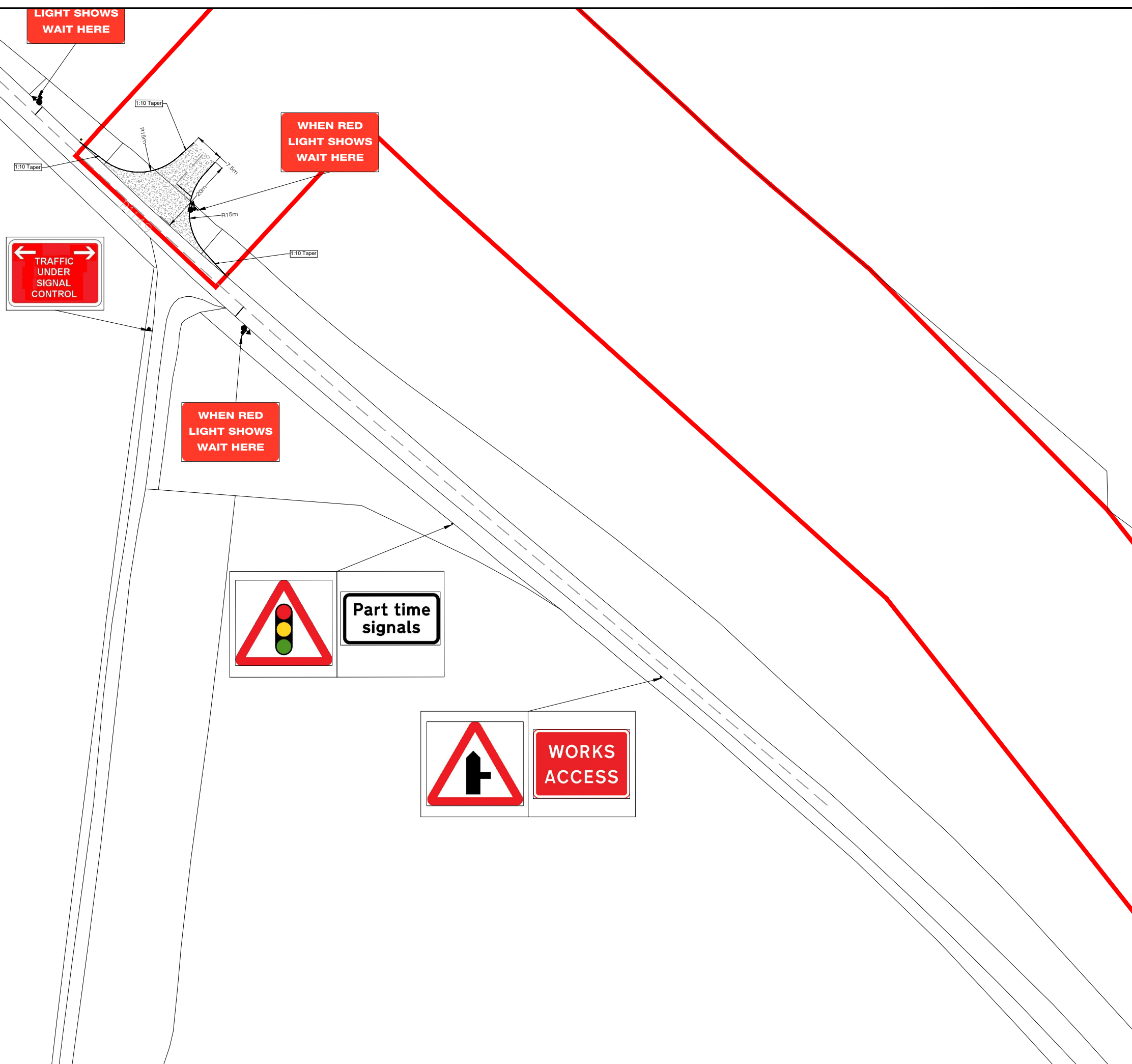

NOTES
 1. Do not scale from this drawing, all dimensions are in metres unless noted otherwise.
 2. This drawing has been based upon Ordnance Survey Maps and Royal HaskoningDHV can not guarantee the accuracy of data.

KEY
 — EXISTING ARRANGEMENT
 — ORDER LIMITS
 — PROPOSED ACCESS BOUNDARY/ROAD MARKINGS
 PROPOSED TEMPORARY ROAD SIGN
 PROPOSED TEMPORARY TRAFFIC LIGHT

FULL DEPTH CARRIAGEWAY CONSTRUCTION WITH BOUND SURFACE

TRAFFIC UNDER SIGNAL CONTROL

LIGHT SHOWS WAIT HERE

WHEN RED LIGHT SHOWS WAIT HERE

WHEN RED LIGHT SHOWS WAIT HERE

Part time signals

WORKS ACCESS

REV	DATE	DESCRIPTION	BY	CHK	APP
D1.0	17.06.22	FIRST ISSUE	JJ	SKT	ADR

REVISIONS

CLIENT

EQUINOR

PROJECT
DUDGEON & SHERINGHAM SHOAL OFFSHORE WIND FARM EXTENSIONS

TITLE
B1149 OULTON DRAFT ACC25 ACCESS DESIGN (SHEET 2 OF 2)



DRAWN	CHECKED	APPROVED
JJ	SKT	ADR

DATE: 17.06.2022 SCALE AT A3: 1:1000 AUTOCAD REF:

DRAWING No: PB8164-RHD-ZZ-XX-GA-R-0004 REVISION: D1.0

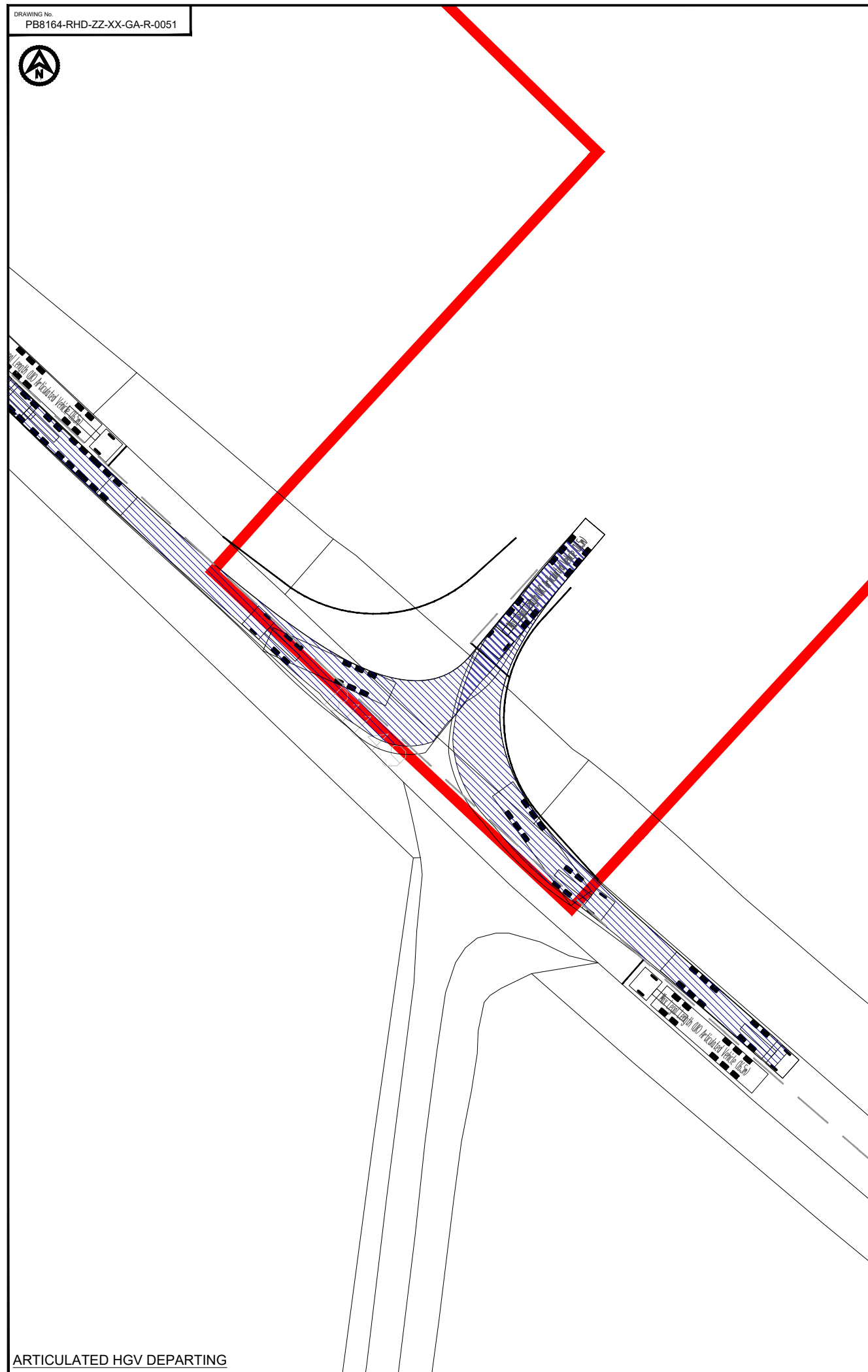

ARTICULATED HGV DEPARTING

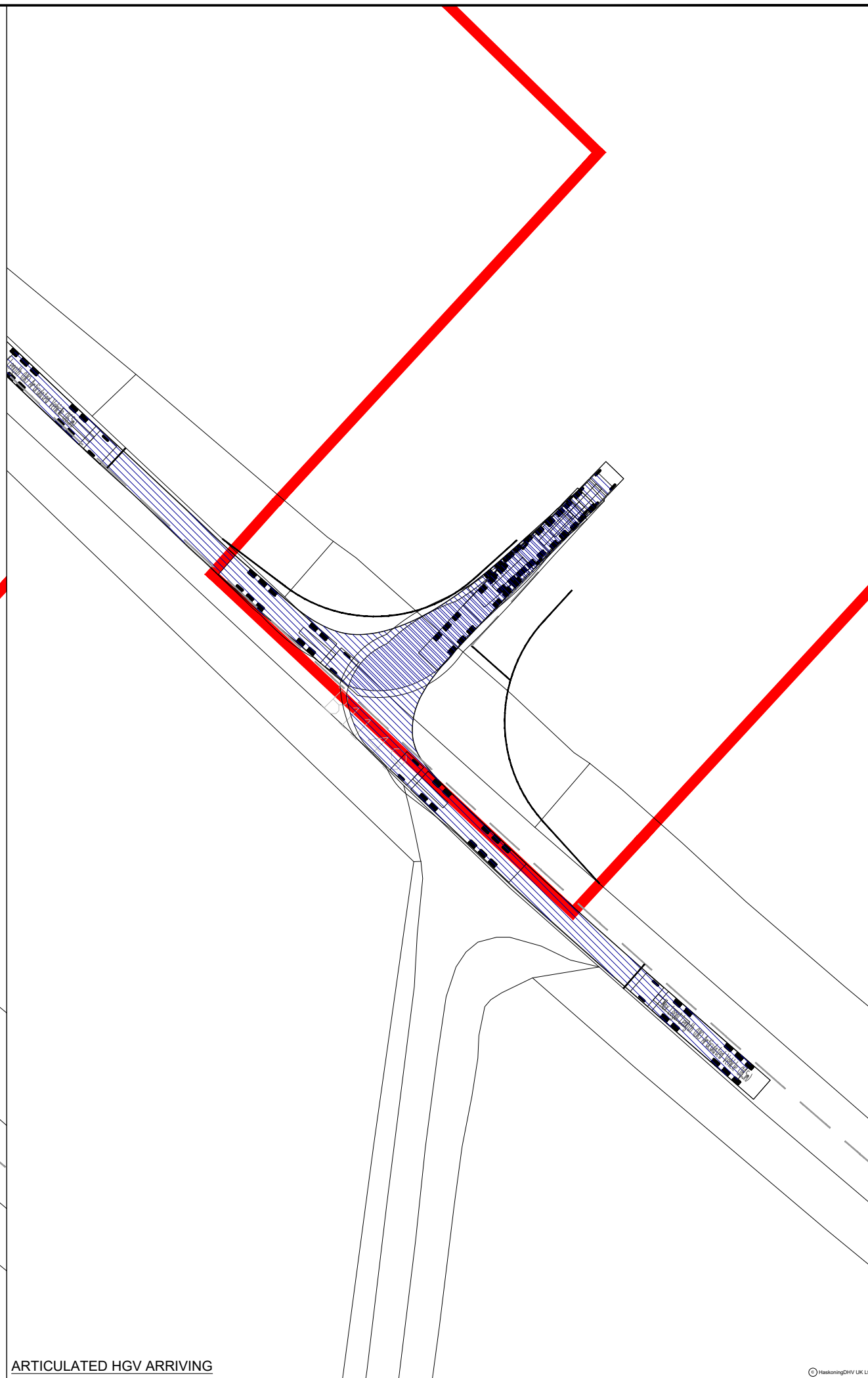

ARTICULATED HGV ARRIVING

NOTES
 1. Do not scale from this drawing, all dimensions are in metres unless noted otherwise.
 2. This drawing has been based upon Ordnance Survey Maps and Royal HaskoningDHV can not guarantee the accuracy of data.

KEY
 — EXISTING ARRANGEMENT
 — ORDER LIMITS
 — PROPOSED ACCESS BOUNDARY/ROAD MARKINGS

VEHICLE TRACKING

Max Legal Length (UK) Articulated Vehicle (16.5m)
 Overall Length 16.50m
 Overall Width 2.55m
 Overall Body Height 3.28m
 Min Body Ground Clearance 0.41m
 Max Track Width 2.50m
 Lock to lock time 6.88s
 Kerb to Kerb Turning Radius 6.530m

▨ VEHICLE BODY SWEEP PATH (FORWARD GEAR)
 - - - VEHICLE CHASSIS SWEEP PATH

REV	DATE	DESCRIPTION	BY	CHK	APP
D1.0	17.06.22	FIRST ISSUE	JL	SKT	ADR

REVISIONS

CLIENT
EQUINOR

PROJECT
**DUDGEON & SHERINGHAM SHOAL
OFFSHORE WIND FARM
EXTENSIONS**

TITLE
**B1149 OULTON
DRAFT
ACC25 ACCESS DESIGN
SWEEP PATH ANALYSIS**



DRAWN	CHECKED	APPROVED
JL	SKT	ADR
DATE	SCALE AT A3	AUTOCAD REF.
17.06.2022	1:500	
DRAWING No. PB8164-RHD-ZZ-XX-GA-R-0051	REVISION	
CLIENT DWG No.		D1.0

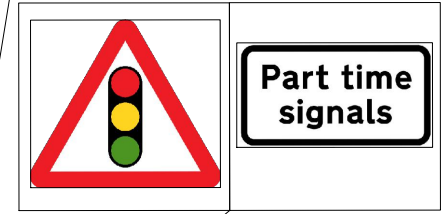



WHEN RED
LIGHT SHOWS
WAIT HERE

WHEN RED
LIGHT SHOWS
WAIT HERE

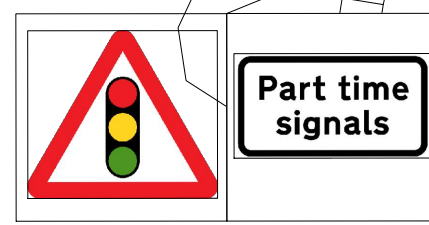
WHEN RED
LIGHT SHOWS
WAIT HERE



NOTES
 1. Do not scale from this drawing, all dimensions are in metres unless noted otherwise.
 2. This drawing has been based upon Ordnance Survey Maps and Royal HaskoningDHV can not guarantee the accuracy of data.

KEY
 — EXISTING ARRANGEMENT
 — ORDER LIMITS
 PROPOSED TEMPORARY ROAD SIGN
 PROPOSED TEMPORARY TRAFFIC LIGHT
 PROPOSED EXTENT OF ROAD WIDENING

REV	DATE	DESCRIPTION	BY	CHK	APP
D1.0	12.07.22	FIRST ISSUE	JL	SKT	ADR

REVISIONS

CLIENT

EQUINOR

PROJECT
DUDGEON & SHERINGHAM SHOAL
OFFSHORE WIND FARM
EXTENSIONS

TITLE
B1149 OULTON
DRAFT
ACC25b ACCESS DESIGN
(SHEET 1 OF 2)



DRAWN	CHECKED	APPROVED
JL	SKT	ADR

DATE: 12.07.2022 SCALE AT A3: 1:1000 AUTOCAD REF:

DRAWING No: PB8164-RHD-ZZ-XX-GA-R-0013 REVISION

CLIENT DWG No: D1.0



WHEN RED LIGHT SHOWS WAIT HERE

WHEN RED LIGHT SHOWS WAIT HERE

WHEN RED LIGHT SHOWS WAIT HERE

NOTES
1. Do not scale from this drawing, all dimensions are in metres unless noted otherwise.
2. This drawing has been based upon Ordnance Survey Maps and Royal HaskoningDHV can not guarantee the accuracy of data.

KEY

- EXISTING ARRANGEMENT
- ORDER LIMITS
- ◀ PROPOSED TEMPORARY ROAD SIGN
- ◀ PROPOSED TEMPORARY TRAFFIC LIGHT
- ▨ PROPOSED EXTENT OF ROAD WIDENING

REV	DATE	DESCRIPTION	BY	CHK	APP
D1.0	12.07.22	FIRST ISSUE	JL	SKT	ADR

REVISIONS

CLIENT

EQUINOR

PROJECT
DUDGEON & SHERINGHAM SHOAL
OFFSHORE WIND FARM
EXTENSIONS

TITLE
B1149 OULTON
DRAFT
ACC25b ACCESS DESIGN
(SHEET 2 OF 2)



DRAWN	CHECKED	APPROVED
JL	SKT	ADR

DATE: 12.07.2022 SCALE AT A3: 1:1000 AUTOCAD REF:

DRAWING No. PB8164-RHD-ZZ-XX-GA-R-0014 REVISION

CLIENT DWG No. D1.0

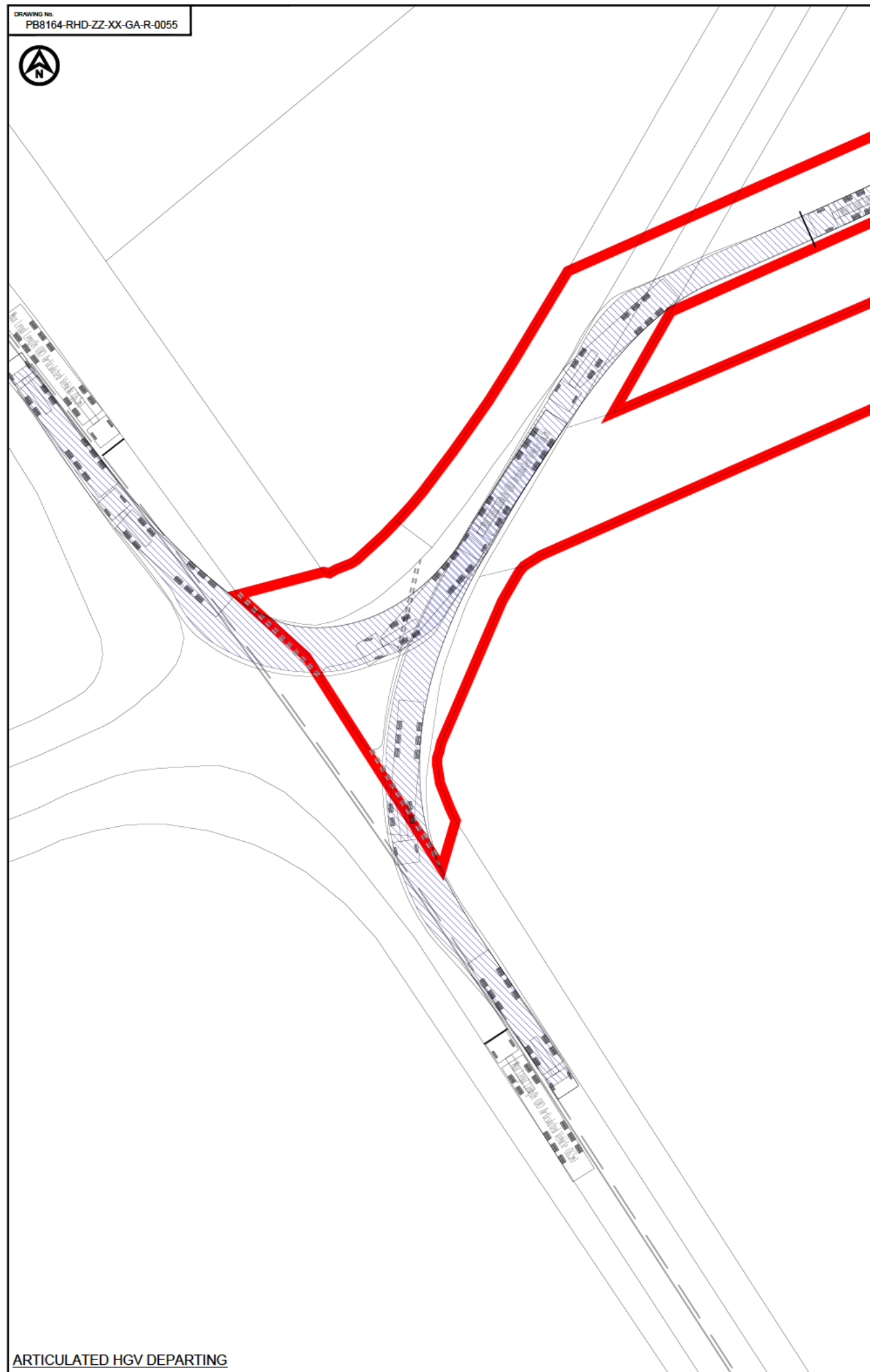

ARTICULATED HGV DEPARTING

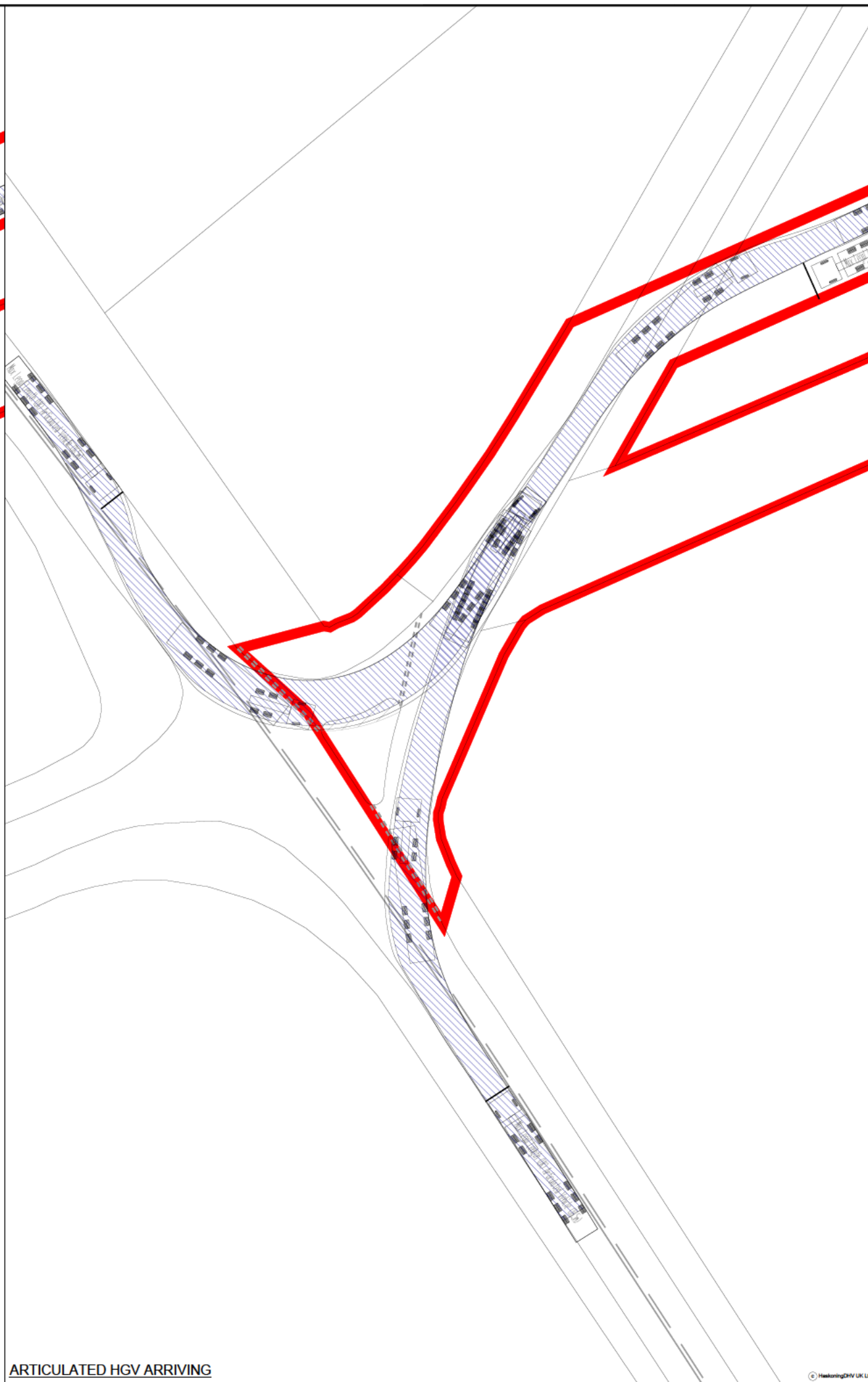

ARTICULATED HGV ARRIVING

NOTES
 1. Do not scale from this drawing, all dimensions are in metres unless noted otherwise.
 2. This drawing has been based upon Ordnance Survey Maps and Royal HaskoningDHV can not guarantee the accuracy of data.

KEY
 — EXISTING ARRANGEMENT
 — ORDER LIMITS

TEMPORARY CARRIAGEWAY WIDENING

VEHICLE TRACKING

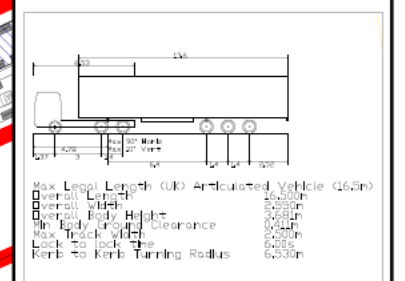

VEHICLE BODY SWEEP PATH (FORWARD GEAR)
 VEHICLE CHASSIS SWEEP PATH

REV	DATE	DESCRIPTION	BY	CHK	APP
D1.0	17.08.22	FIRST ISSUE	JL	SKT	ADR

REVISIONS

CLIENT

EQUINOR

PROJECT
DUDGEON & SHERINGHAM SHOAL
OFFSHORE WIND FARM
EXTENSIONS

TITLE
B1149 OULTON
DRAFT
ACC25 ACCESS CONCEPT
SWEEP PATH ANALYSIS



DRAWN	CHECKED	SKT	APPROVED	ADR
JL				
DATE	SCALE AT A3	AUTOCAD REF.		
17.05.2022	1:500			
DRAWING No. PB8164-RHD-ZZ-XX-GA-R-0055	REVISION			
CLIENT DWG No.	D1.0			

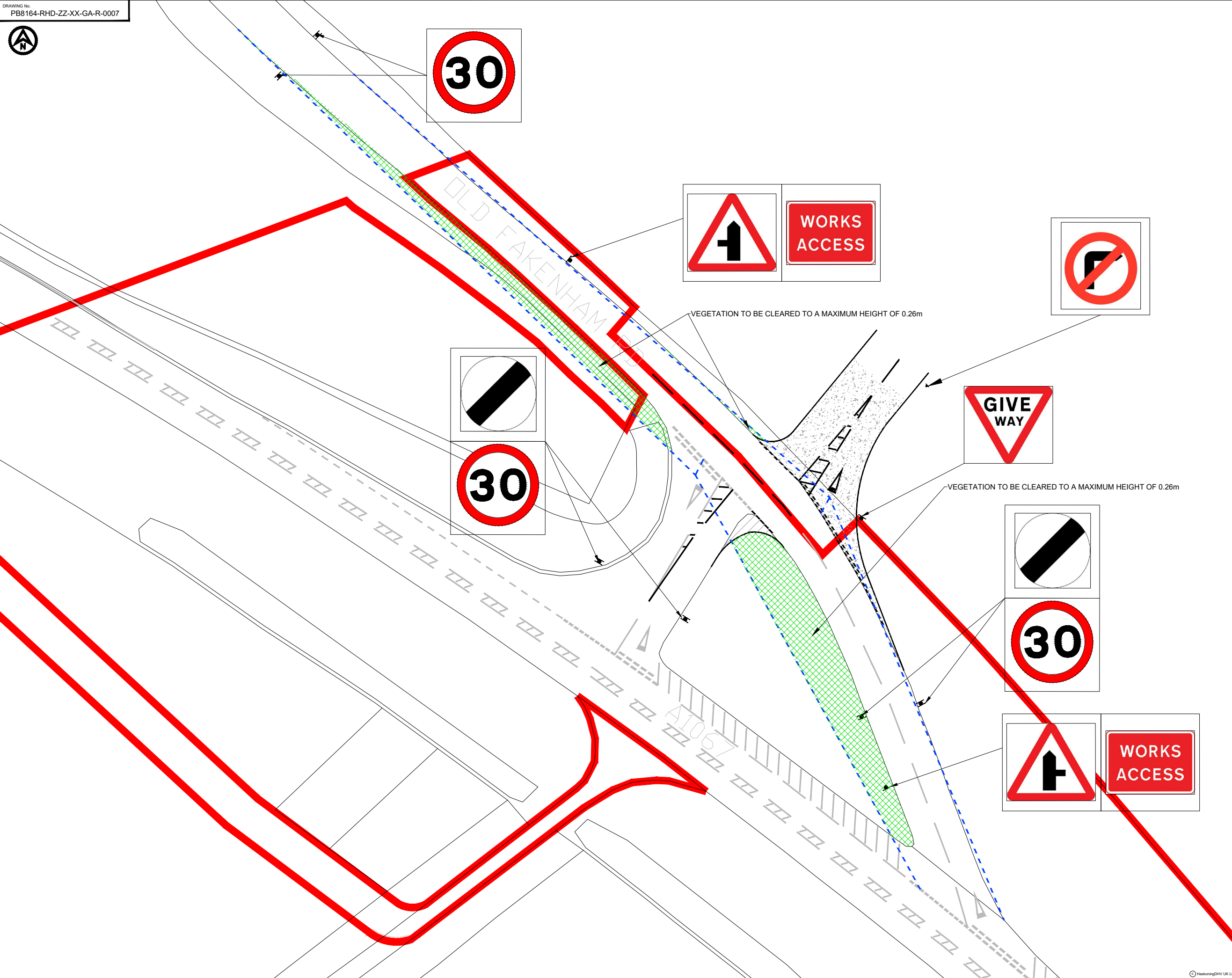

- NOTES**
1. Do not scale from this drawing, all dimensions are in metres unless noted otherwise.
 2. This drawing has been based upon Ordnance Survey Maps and Royal HaskoningDHV can not guarantee the accuracy of data.
 3. X-distance - the set back from the nearest edge of the carriageway from which the access will be taken
 4. Y-Distance - the SSD measured along the nearest edge of the carriageway to its intersection with the centreline of the access.
 5. All vegetation to be cleared/trimmed to a height of 0.26m within identified visibility envelope and thereafter maintained in accordance with Norfolk County Council maintenance practices.

KEY

- EXISTING ARRANGEMENT
- ORDER LIMITS
- PROPOSED ACCESS BOUNDARY/ROAD MARKINGS
- VISIBILITY SPLAY (SEE BELOW)

A1067 ATLAS WORKS

Posted Speed Limit (PSL) (mph)	60
Measured 85 th percentile speed (mph)	36.0
Proposed temporary speed limit (mph)	30
Required Y-distance SSD for proposed temporary speed (m)	90

- PROPOSED TEMPORARY ROAD SIGN**
- AREA TO BE CLEARED TO HEIGHT OF 0.26m TO ACHIEVE REQUIRED VISIBILITY SPLAYS
 - FULL DEPTH CARRIAGEWAY CONSTRUCTION WITH BOUND SURFACE
 - PROPOSED EXTENT OF ROAD WIDENING

REV	DATE	DESCRIPTION	BY	CHK	APP
D3.0	25.04.21	UPDATED NOTES	CB	SKT	ADR
D2.0	16.11.21	VISIBILITY SPLAY INCREASED	SKT	SKT	ADR
D1.0	26.10.21	FIRST ISSUE	SKT	SKT	ADR

REVISIONS

CLIENT

EQUINOR

PROJECT
DUDGEON & SHERINGHAM SHOAL
OFFSHORE WIND FARM
EXTENSIONS

TITLE
A1067 / OLD FAKENHAM ROAD
DRAFT
ACC33 ACCESS DESIGN



DRAWN	CHECKED	APPROVED
SKT	SKT	ADR
DATE: 26.10.2021	SCALE AT A3: 1:500	AUTOCAD REF:

DRAWING No. PB8164-RHD-ZZ-XX-GA-R-0007
CLIENT DWG No. D3.0

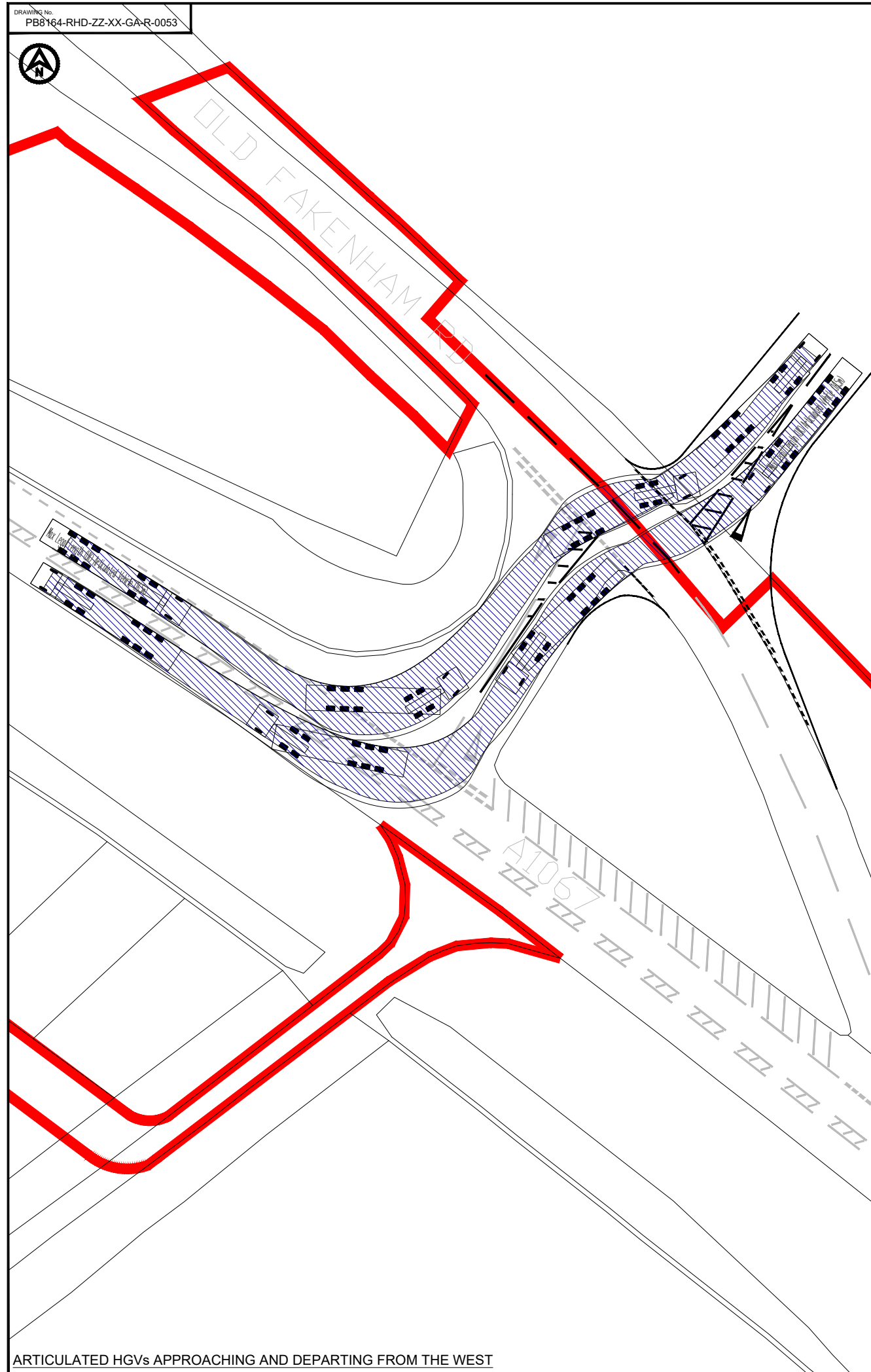

ARTICULATED HGVs APPROACHING AND DEPARTING FROM THE WEST

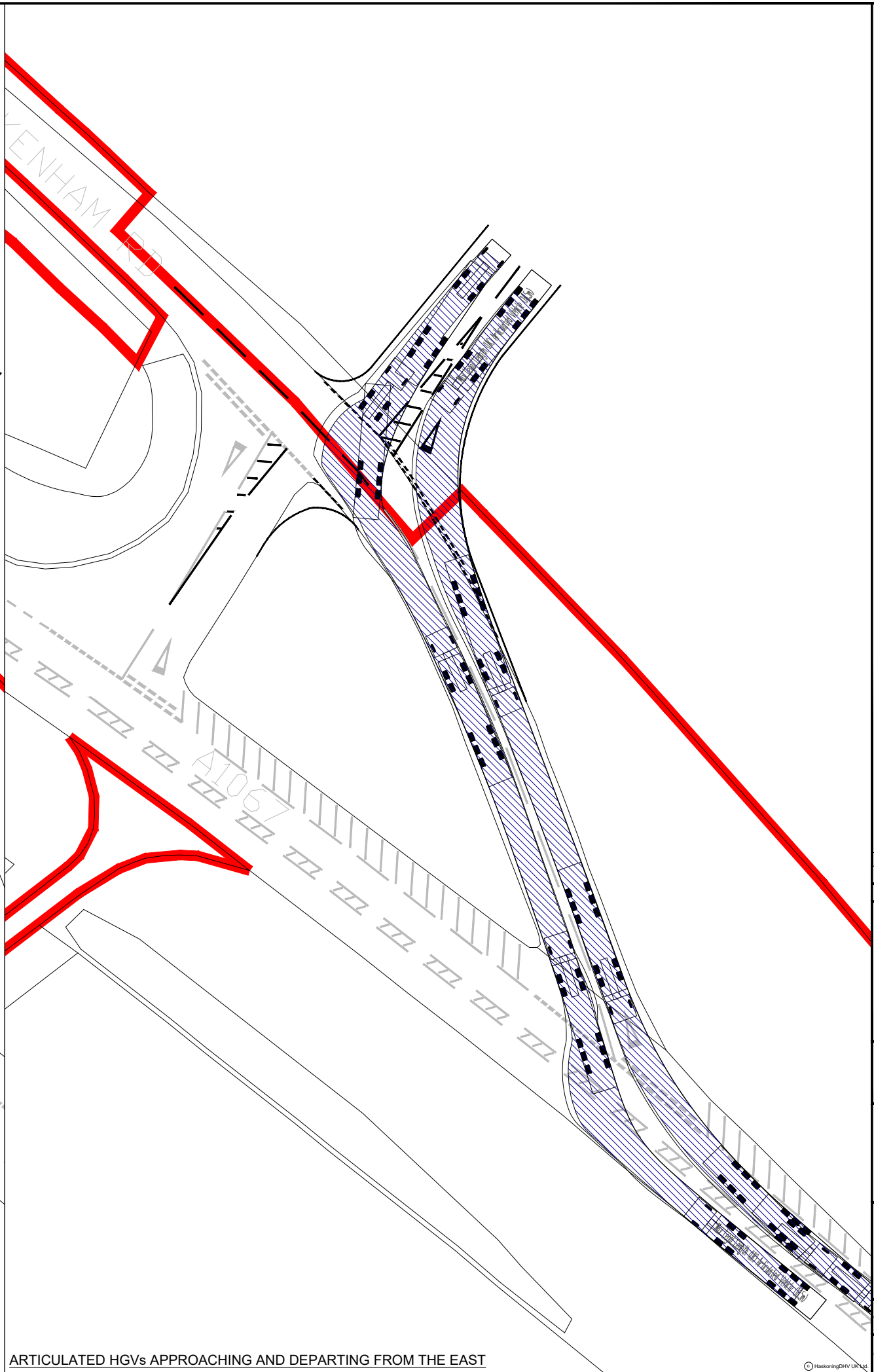

ARTICULATED HGVs APPROACHING AND DEPARTING FROM THE EAST

NOTES
 1. Do not scale from this drawing, all dimensions are in metres unless noted otherwise.
 2. This drawing has been based upon Ordnance Survey Maps and Royal HaskoningDHV can not guarantee the accuracy of data.

KEY
 — EXISTING ARRANGEMENT
 — ORDER LIMITS
 — PROPOSED ACCESS BOUNDARY/ROAD MARKINGS

VEHICLE TRACKING

Max Legal Length (UK) Articulated Vehicle (16.5m)
 Overall Length 16.50m
 Overall Width 2.55m
 Overall Body Height 5.28m
 Min Body Ground Clearance 0.41m
 Max Track Width 2.50m
 Lock to lock time 6.88m
 Kerb to Kerb Turning Radius 6.55m

▨ VEHICLE BODY SWEEP PATH (FORWARD GEAR)
 — VEHICLE CHASSIS SWEEP PATH

REV	DATE	DESCRIPTION	BY	CHK	APP
D1.0	31.08.21	FIRST ISSUE	SKT	SKT	ADR

REVISIONS

CLIENT

EQUINOR

PROJECT

DUDGEON & SHERINGHAM SHOAL
OFFSHORE WIND FARM
EXTENSIONS

TITLE

A1067 OLD FAKENHAM ROAD
DRAFT
ACC33 ACCESS DESIGN
SWEEP PATH ANALYSIS



DRAWN	CHECKED	APPROVED
SKT	SKT	ADR
DATE	SCALE AT A3	AUTOCAD REF.
31.08.2021	1:500	
DRAWING No. PB8164-RHD-ZZ-XX-GA-R-0053	REVISION	
CLIENT DWG No.	D1.0	



- NOTES**
1. Do not scale from this drawing, all dimensions are in metres unless noted otherwise.
 2. This drawing has been based upon Ordnance Survey Maps and Royal HaskoningDHV can not guarantee the accuracy of data.
 3. X-distance - the set back from the nearest edge of the carriageway from which the access will be taken
 4. Y-Distance - the SSD measured along the nearest edge of the carriageway to its intersection with the centreline of the access.
 5. All vegetation to be cleared/trimmed to a height of 0.26m within identified visibility envelope and thereafter maintained in accordance with National Highways maintenance practices.

- KEY**
- EXISTING ARRANGEMENT
 - ORDER LIMITS
 - PROPOSED ACCESS BOUNDARY/ROAD MARKINGS
 - VISIBILITY SPLAY (SEE BELOW)

A47 EASTON	
Posted Speed Limit (PSL) (mph)	60
Measured 85 th percentile speed (mph)	N/A
Proposed temporary speed limit (mph)	40
Required Y-distance SSD for PSL (m)	215

- PROPOSED TEMPORARY ROAD SIGN
- AREA TO BE CLEARED TO A HEIGHT OF 0.26m TO ACHIEVE REQUIRED VISIBILITY SPLAYS
- FULL DEPTH CARRIAGEWAY CONSTRUCTION WITH BOUND SURFACE
- PHYSICAL TRAFFIC ISLAND

REV	DATE	DESCRIPTION	BY	CHK	APP
P02	27.03.23	SPLITTER ISLAND ADDED	CB	SKT	ADR
D1.0	21.06.22	FIRST ISSUE	JJ	SKT	ADR

REVISIONS

CLIENT

EQUINOR

PROJECT
DUDGEON & SHERINGHAM SHOAL
OFFSHORE WIND FARM
EXTENSIONS

TITLE
A47 EASTON
DRAFT
ACC47 ACCESS DESIGN
(SHEET 1 OF 2)



DRAWN	CHECKED	APPROVED
JJ	SKT	ADR

DATE	SCALE AT AS	AUTOCAD REF.
21.06.2022	1:1000	

DRAWING No.	REVISION
PB8164-RHD-ZZ-XX-GA-R-0006	P02

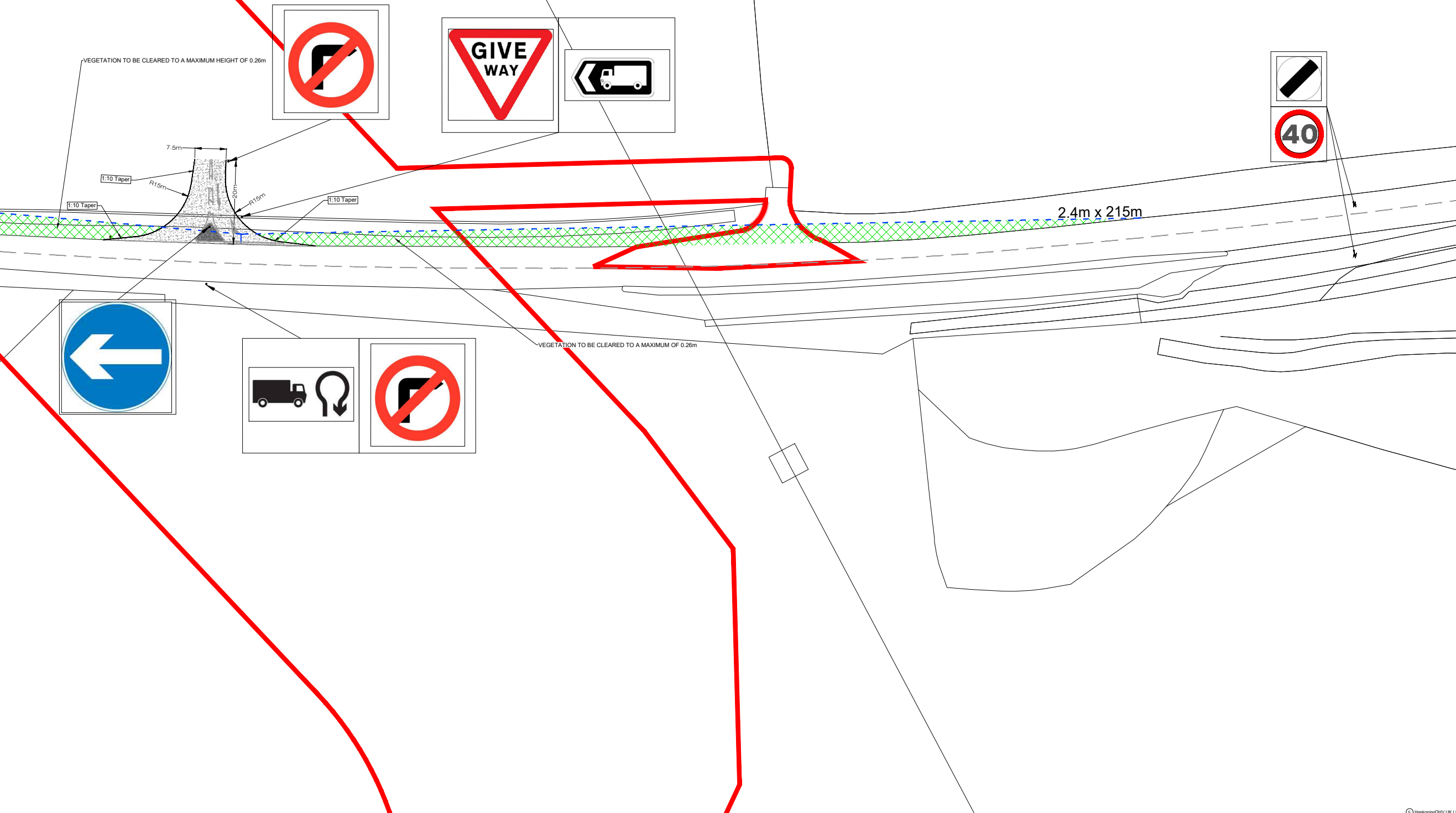

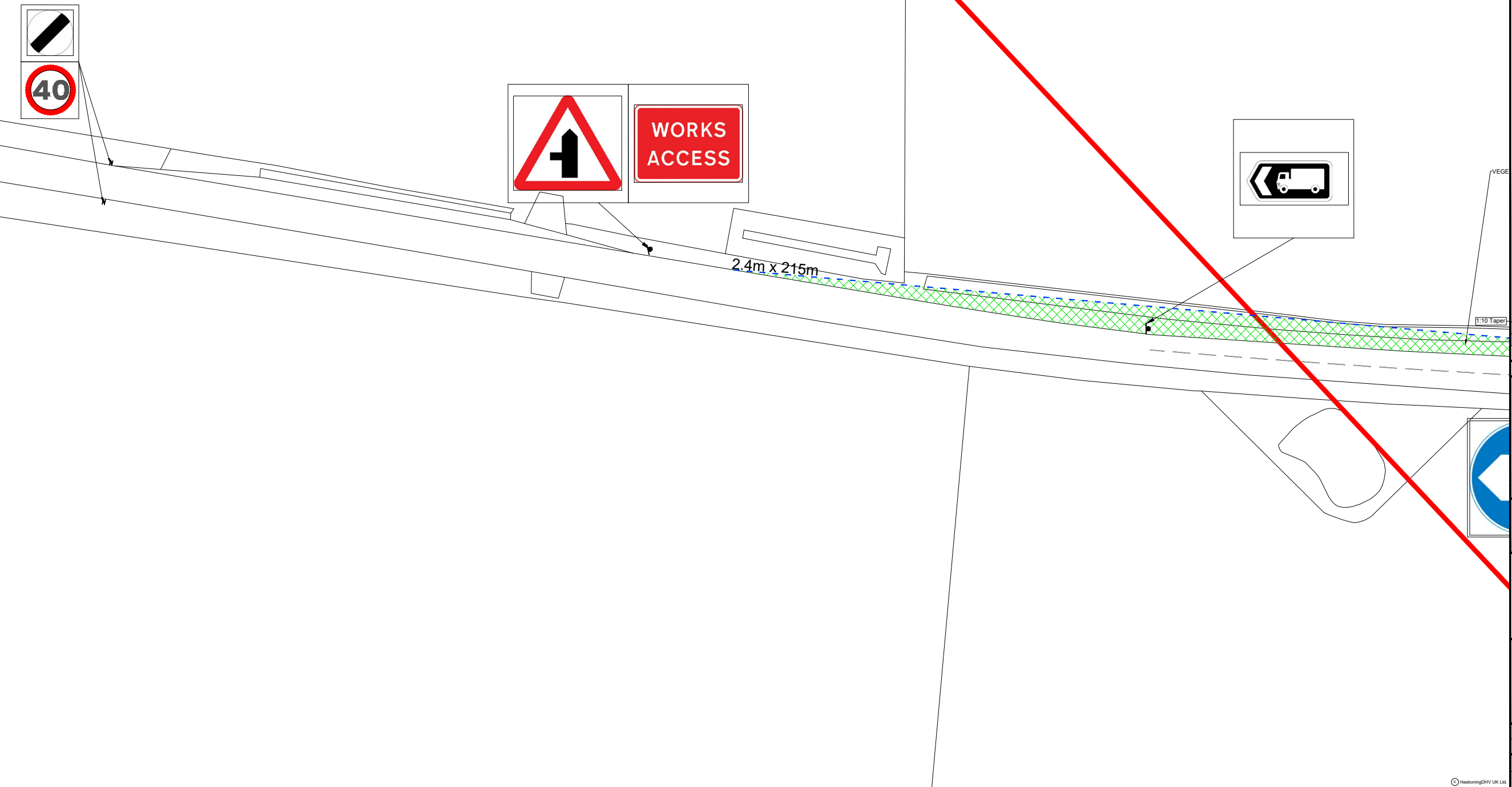

- NOTES**
1. Do not scale from this drawing, all dimensions are in metres unless noted otherwise.
 2. This drawing has been based upon Ordnance Survey Maps and Royal HaskoningDHV can not guarantee the accuracy of data.
 3. X-distance - the set back from the nearest edge of the carriageway from which the access will be taken
 4. Y-Distance - the SSD measured along the nearest edge of the carriageway to its intersection with the centreline of the access.
 5. All vegetation to be cleared/trimmed to a height of 0.26m within identified visibility envelope and thereafter maintained in accordance with National Highways maintenance practices.

- KEY**
- EXISTING ARRANGEMENT
 - ORDER LIMITS
 - PROPOSED ACCESS BOUNDARY/ROAD MARKINGS
 - VISIBILITY SPLAY (SEE BELOW)

A47 EASTON	
Posted Speed Limit (PSL) (mph)	60
Measured 85 th percentile speed (mph)	N/A
Proposed temporary speed limit (mph)	40
Required Y-distance SSD for PSL (m)	215

- PROPOSED TEMPORARY ROAD SIGN
- AREA TO BE CLEARED TO A HEIGHT OF 0.26m ACHIEVE REQUIRED VISIBILITY SPLAYS
- FULL DEPTH CARRIAGEWAY CONSTRUCTION WITH BOUND SURFACE
- PHYSICAL TRAFFIC ISLAND

REV	DATE	DESCRIPTION	BY	CHK	APP
P02	27.03.23	SPLITTER ISLAND ADDED	CB	SKT	ADR
D1.0	21.06.22	FIRST ISSUE	JI	SKT	ADR

REVISIONS

CLIENT

EQUINOR

PROJECT
DUDGEON & SHERINGHAM SHOAL
OFFSHORE WIND FARM
EXTENSIONS

TITLE
A47 EASTON
DRAFT
ACC47 ACCESS DESIGN
(SHEET 2 OF 2)



DRAWN	CHECKED	APPROVED
JI	SKT	ADR
DATE	SCALE AT AS	AUTOCAD REF.
21.06.2022	1:1,000	
DRAWING No. PB8164-RHD-ZZ-XX-GA-R-0005	REVISION	
CLIENT DWG No.		P02



NOTES
 1. Do not scale from this drawing, all dimensions are in metres unless noted otherwise.
 2. This drawing has been based upon Ordnance Survey Maps and Royal HaskoningDHV can not guarantee the accuracy of data.

KEY
 — EXISTING ARRANGEMENT
 — ORDER LIMITS
 — PROPOSED ACCESS BOUNDARY/ROAD MARKINGS

VEHICLE TRACKING

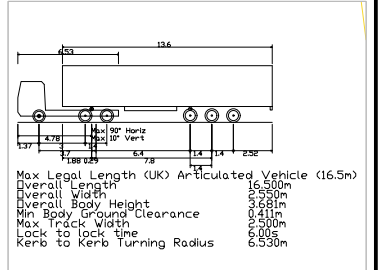

▨ VEHICLE BODY SWEEP PATH (FORWARD GEAR)
 — VEHICLE CHASSIS SWEEP PATH

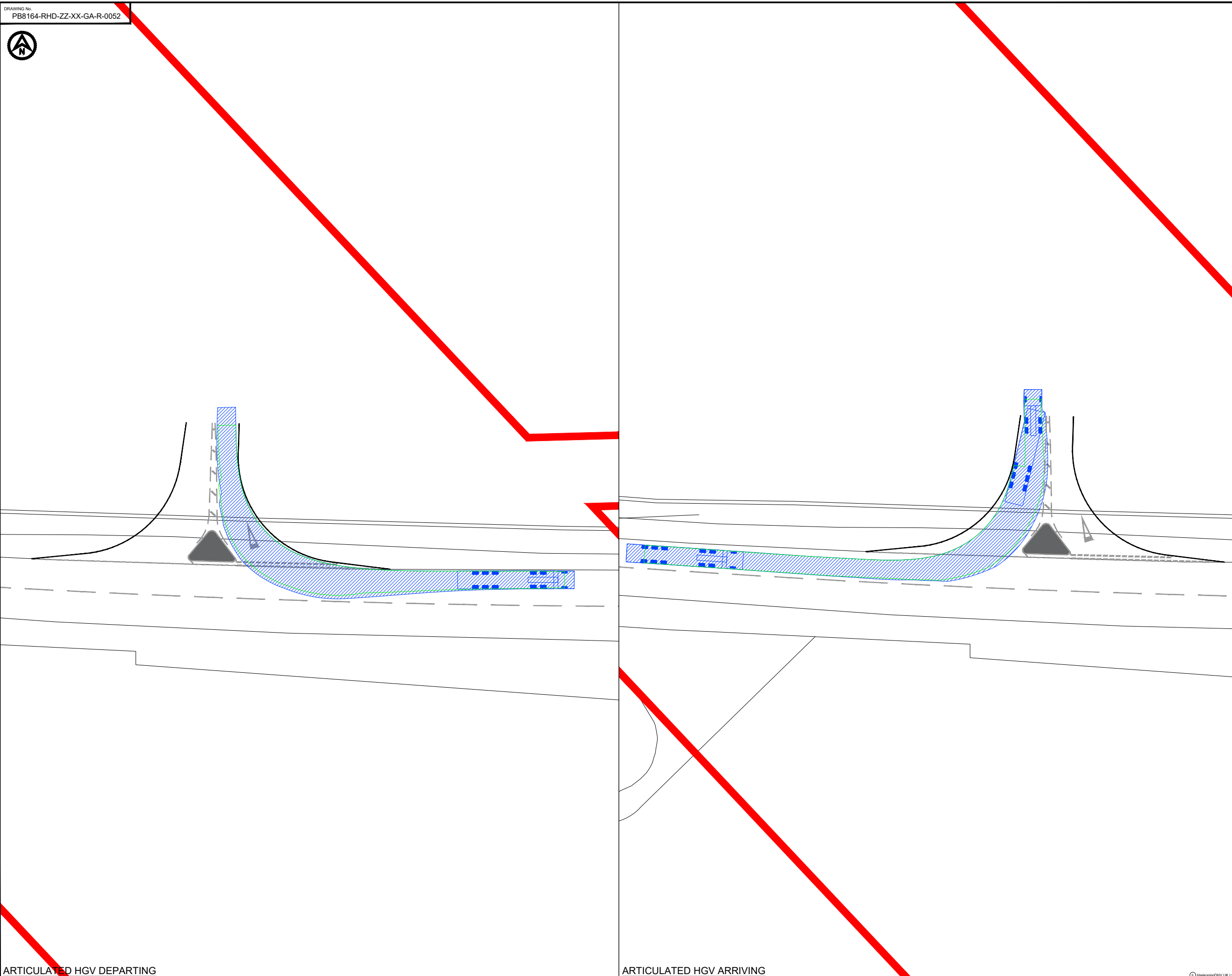

PO2	27.03.23	SPLITTER ISLAND ADDED	CB	SKT	ADR
D1.0	21.06.22	FIRST ISSUE	JJ	SKT	ADR
REV	DATE	DESCRIPTION	BY	CHK	APP

REVISIONS

CLIENT

EQUINOR

PROJECT
 DUDGEON & SHERINGHAM SHOAL
 OFFSHORE WIND FARM
 EXTENSIONS

TITLE
 A47 EASTON
 DRAFT
 ACC47 ACCESS DESIGN
 SWEEP PATH ANALYSIS



DRAWN	JJ	CHECKED	SKT	APPROVED	ADR
DATE	21.06.2022	SCALE AT A3	1:500	AUTOCAD REF.	
DRAWING No.	PB8164-RHD-ZZ-XX-GA-R-0052			REVISION	
CLIENT DWG No.				REVISION	P02

ARTICULATED HGV DEPARTING

ARTICULATED HGV ARRIVING

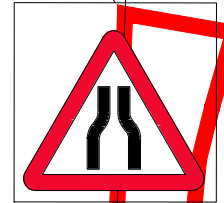
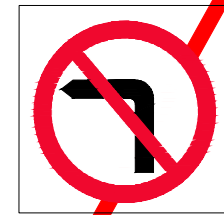
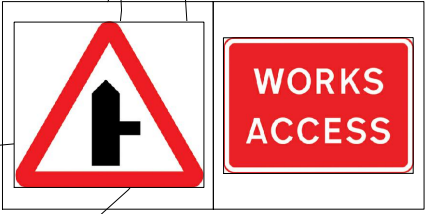
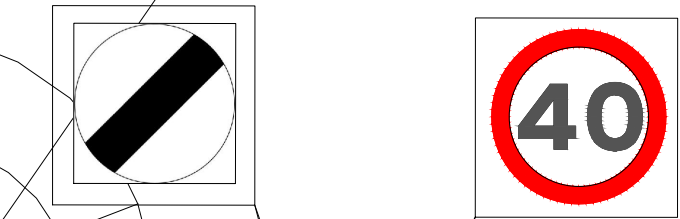

- NOTES**
- Do not scale from this drawing, all dimensions are in metres unless noted otherwise.
 - This drawing has been based upon Ordnance Survey Maps and Royal HaskoningDHV can not guarantee the accuracy of data.
 - X-distance - the set back from the nearest edge of the carriageway from which the access will be taken
 - Y-Distance - the SSD measured along the nearest edge of the carriageway to its intersection with the centreline of the access.
 - All vegetation to be cleared/trimmed to a height of 0.26m within identified visibility envelope and thereafter maintained in accordance with Norfolk County Council maintenance practices.

- KEY**
- EXISTING ARRANGEMENT
 - ORDER LIMITS
 - PROPOSED ACCESS BOUNDARY/ROAD MARKINGS
 - VISIBILITY SPLAY (SEE BELOW)

A140 MANGREEN LANE

Posted Speed Limit (PSL) (mph)	60
Measured 85 th percentile speed (mph)	28.4
Proposed temporary speed limit (mph)	40
Required Y-distance SSD for 85 th percentile speed (m)	43

- PROPOSED TEMPORARY ROAD SIGN
- AREA TO BE CLEARED TO A HEIGHT OF 0.26m TO ACHIEVE REQUIRED VISIBILITY SPLAYS
- FULL DEPTH CARRIAGEWAY CONSTRUCTION WITH BOUND SURFACE
- PROPOSED EXTENT OF ROAD WIDENING

REV	DATE	DESCRIPTION	BY	CHK	APP
D3.0	25.04.21	UPDATE TO NOTES	CB	SKT	ADR
D2.0	22.11.21	A140 VISIBILITY SPLAYS ADDED	SKT	SKT	ADR
D1.0	31.08.21	FIRST ISSUE	SKT	SKT	ADR

REVISIONS

CLIENT

EQUINOR

PROJECT
DUDGEON & SHERINGHAM SHOAL
OFFSHORE WIND FARM
EXTENSIONS

TITLE
A140 / MANGREEN LANE
DRAFT
ACC76 ACCESS DESIGN



DRAWN	SKT	CHECKED	SKT	APPROVED	ADR
DATE	31.08.2021	SCALE AT A3	1:500	AUTOCAD REF.	

DRAWING No.	PB8164-RHD-ZZ-XX-GA-R-0008	REVISION	D3.0
CLIENT DWG No.			



NOTES
 1. Do not scale from this drawing, all dimensions are in metres unless noted otherwise.
 2. This drawing has been based upon Ordnance Survey Maps and Royal HaskoningDHV can not guarantee the accuracy of data.

KEY
 — EXISTING ARRANGEMENT
 — ORDER LIMITS
 — PROPOSED ACCESS BOUNDARY/ROAD MARKINGS

VEHICLE TRACKING

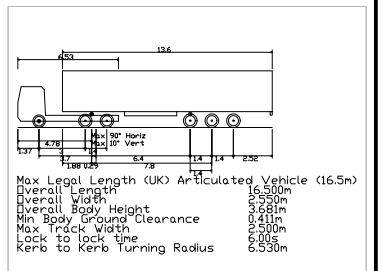

▨ VEHICLE BODY SWEEP PATH (FORWARD GEAR)
 — VEHICLE CHASSIS SWEEP PATH

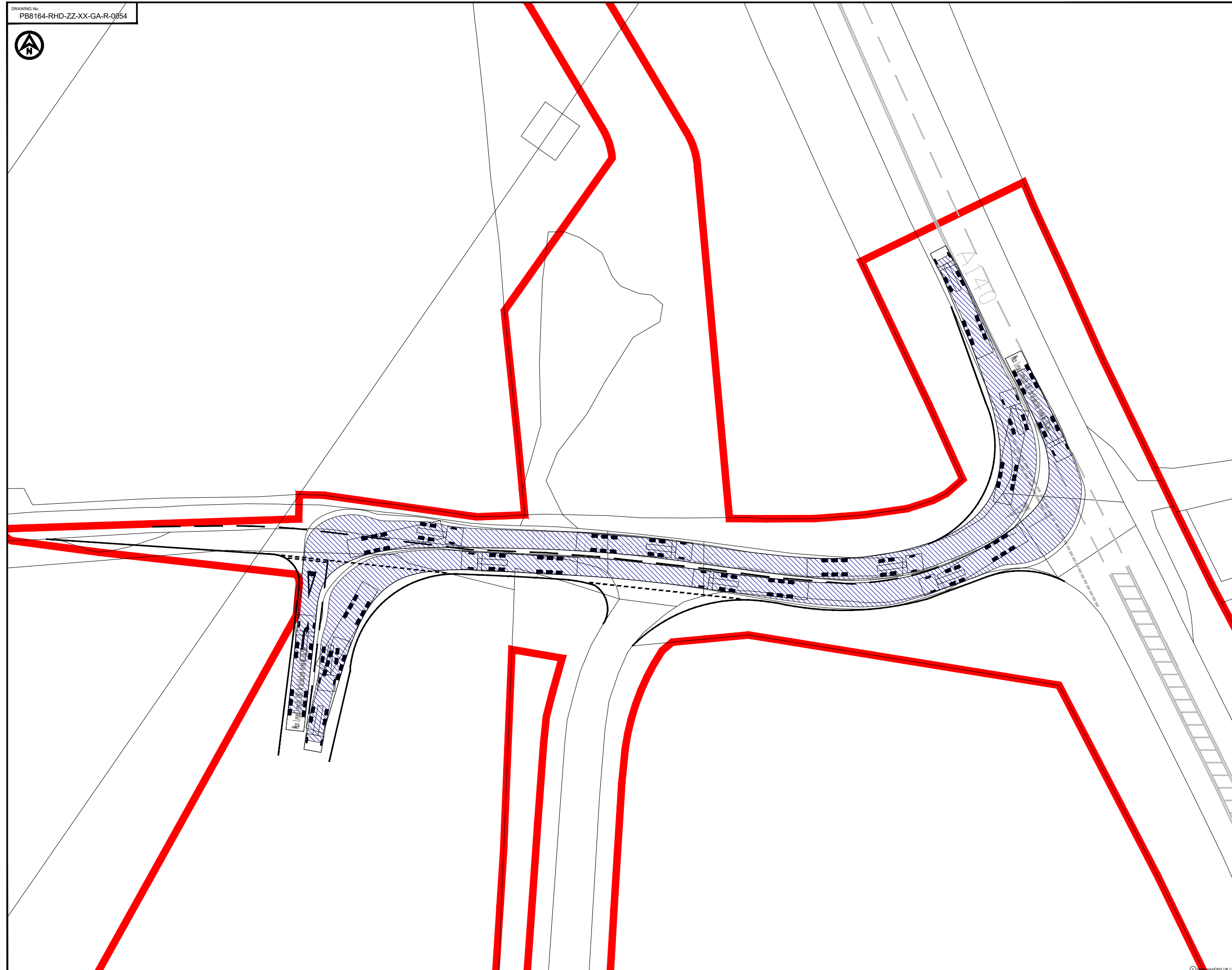

REV	DATE	DESCRIPTION	BY	CHK	APP
D1.0	31.08.21	FIRST ISSUE	SKT	SKT	ADR

REVISIONS

CLIENT
 EQUINOR

PROJECT
 DUDGEON & SHERINGHAM SHOAL
 OFFSHORE WIND FARM
 EXTENSIONS

TITLE
 A140 / MANGREEN LANE
 DRAFT
 ACC76 ACCESS DESIGN
 SWEEP PATH ANALYSIS



DRAWN	CHECKED	APPROVED
SKT	SKT	ADR
DATE	SCALE AT A3	AUTOCAD REF.
31.08.2021	1:500	
DRAWING No. PB8164-RHD-ZZ-XX-GA-R-0054	REVISION	
CLIENT DWG No.		D1.0



NOTES

- DO NOT SCALE FROM THIS DRAWING. ALL DIMENSIONS ARE IN METERS UNLESS NOTED OTHERWISE.
- ALL VEGETATION TO BE CLEARED/TRIMMED WITHIN IDENTIFIED VISIBILITY ENVELOPE AND THEREAFTER MAINTAINED IN ACCORDANCE WITH NORFOLK COUNTY COUNCIL MAINTENANCE PRACTICES.

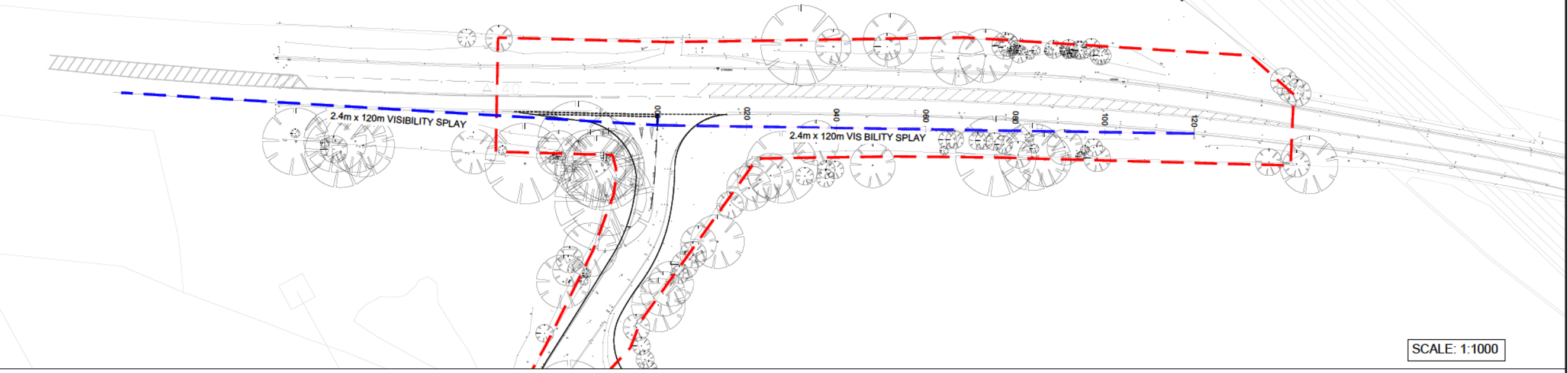

SCALE: 1:1000

VISIBILITY SPLAY
Chainage 0.00 - 120.00

LONG SECTIONS KEY:

- VERTICAL VISIBILITY SPLAY
- EXISTING GROUND PROFILE

HORIZONTAL SCALE 1:500
VERTICAL SCALE 1:100

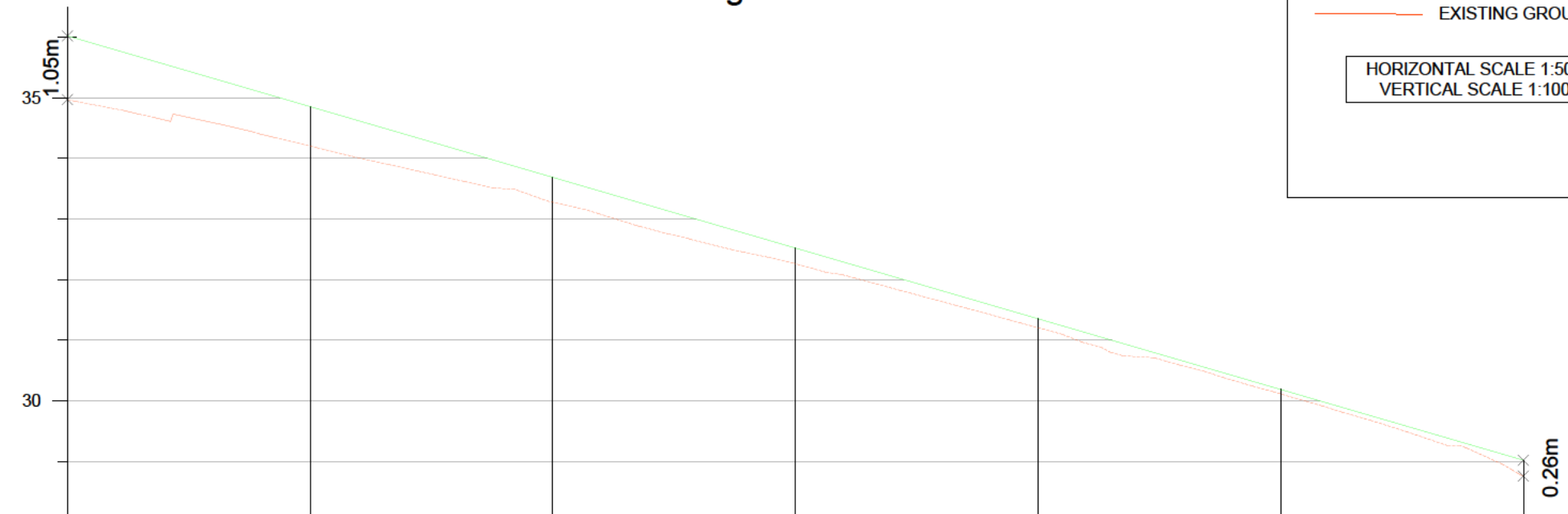

CHAINAGE	0.000	20.000	40.000	60.000	80.000	100.000	119.999
VISIBILITY SPLAY	36.019	34.853	33.687	32.520	31.354	30.188	29.022
EXISTING LEVELS	34.969	34.202	33.275	32.262	31.207	30.115	29.762
HORIZONTAL GEOMETRY	L = 120.00						

REV	DATE	DESCRIPTION	BY	CHK	APP
D1.0	24.02.22	ISSUED FOR INFORMATION	DW	SKT	ADR

REVISIONS

CLIENT

EQUINOR

PROJECT

DUDGEON & SHERINGHAM SHOAL OFFSHORE WIND FARM EXTENSIONS

TITLE

ACC75 VISIBILITY SPLAY PLAN



DRAWN	CHECKED	SKT	APPROVED	ADR
DW	SKT	SKT	ADR	ADR

DATE: 24.02.2022 SCALE: AS SHOWN AUTOCAD REF.

DRAWING No: PB8164-RHD-ZZ-XX-GA-R-0009 REVISION

CLIENT DWG No. D1.0

LARGE TIPPER IN

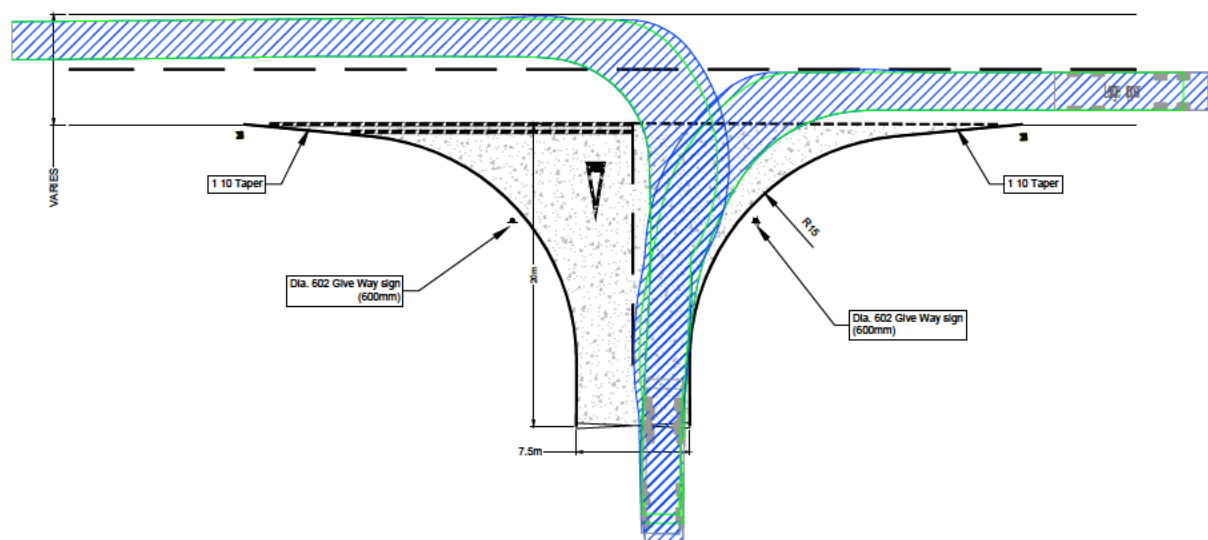

LOW LOADER IN

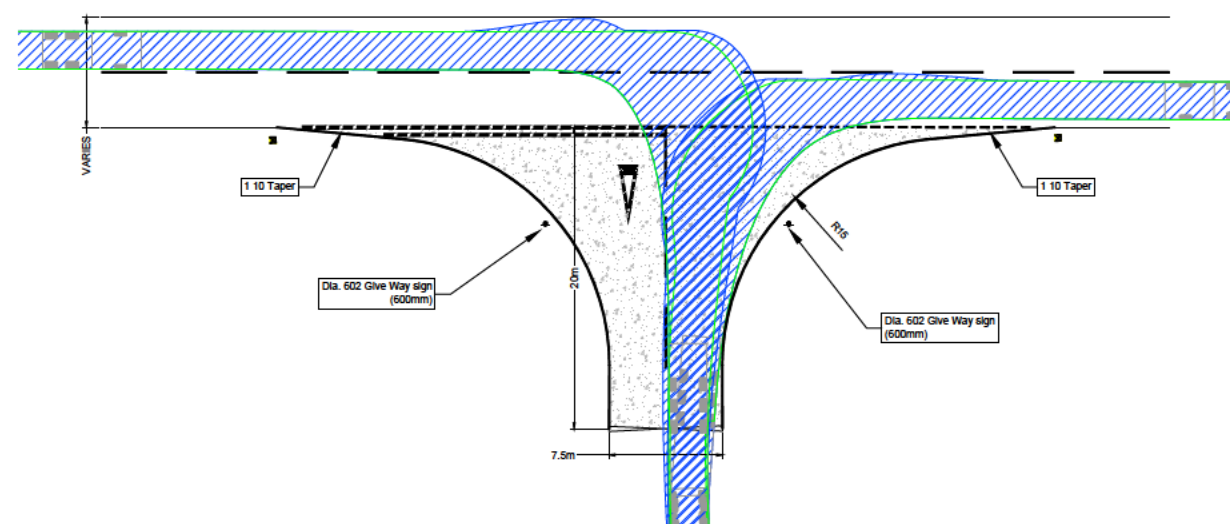

LARGE TIPPER OUT

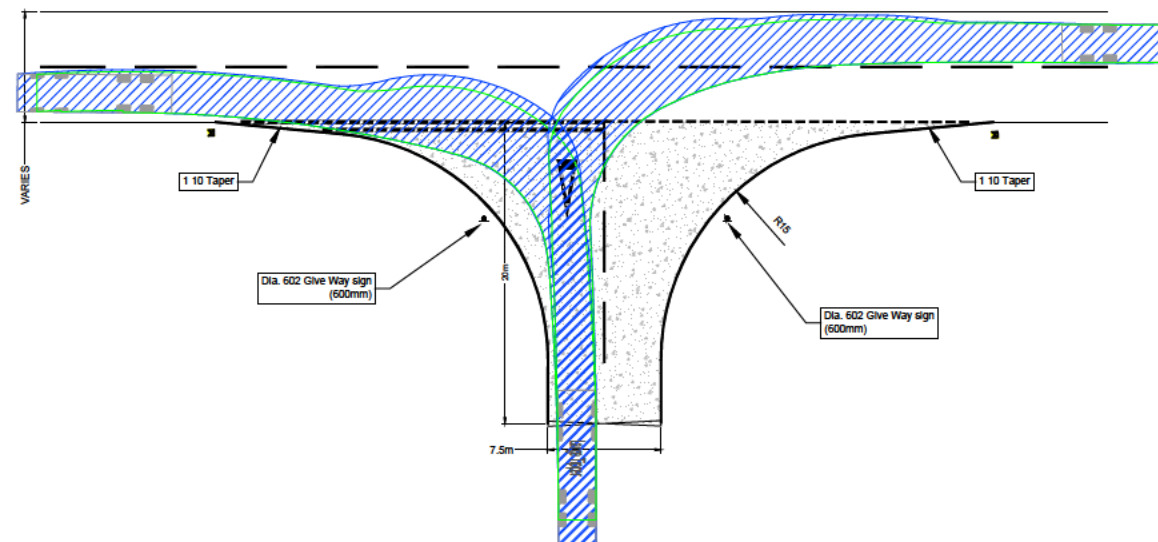

LOW LOADER OUT

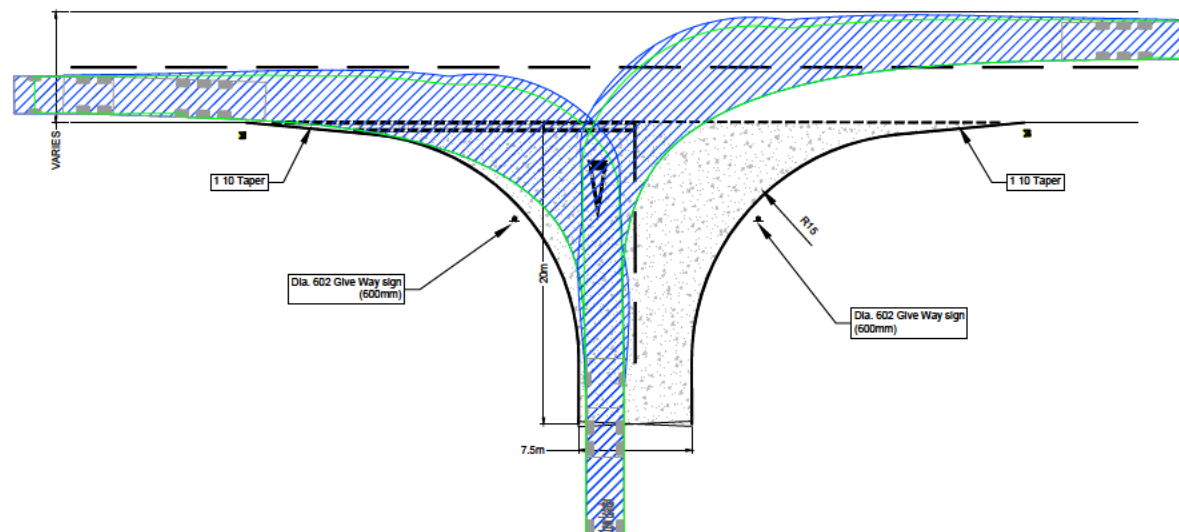

- NOTES**
- Do not scale from this drawing, all dimensions are in metres unless noted otherwise.
 - Exact junction types and geometry to be determined from relevant section of Design Manual for Roads & Bridges (CD 123).
 - All road markings and signs to conform with the Traffic Signs Regulation and General Directions 2016 and Chapter 8.

- KEY**
- EXISTING METALED ROAD BOUNDARY
 - PROPOSED ACCESS BOUNDARY/ROAD MARKINGS
 - PROPOSED GATE
 - PROPOSED PLASTIC DEMARCATION BOLLARD
 - PROPOSED POST MOUNTED TRAFFIC SIGN
 - PROPOSED ACCESS CONSTRUCTION

VEHICLE TRACKING

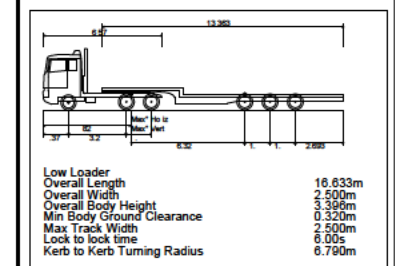
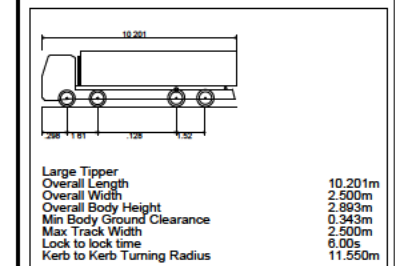

- VEHICLE BODY SWEEP PATH (FORWARD GEAR)
- VEHICLE CHASSIS SWEEP PATH

REV	DATE	DESCRIPTION	BY	CHK	APP
REVISIONS					

CLIENT

EQUINOR

PROJECT
DUDGEON & SHERINGHAM SHOAL
OFFSHORE WIND FARM
EXTENSIONS

TITLE
TYPE A ACCESS
DMRB A/B ROAD JUNCTION
20t TIPPER & LARGE LOW LOADER



DRAWN	JI	CHECKED	SKT	APPROVED	ADR
DATE	06.07.22	SCALE AT A3	1:500	CLIENTS REF.	

DRAWING No: PB8164-RHD-ZZ-XX-GA-R-0010
CLIENT DWG No.

REVIS ON
D0.1

TYPE B ACCESS - LARGE TIPPER IN

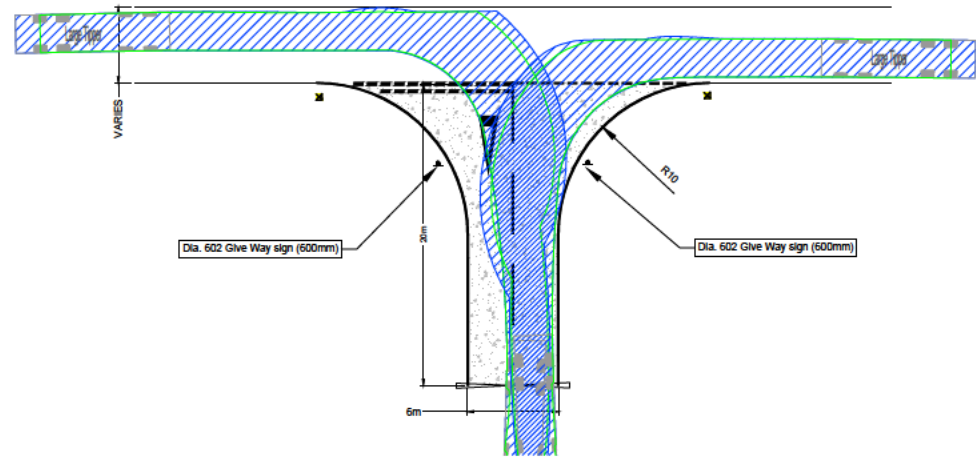

TYPE B ACCESS - LARGE TIPPER OUT

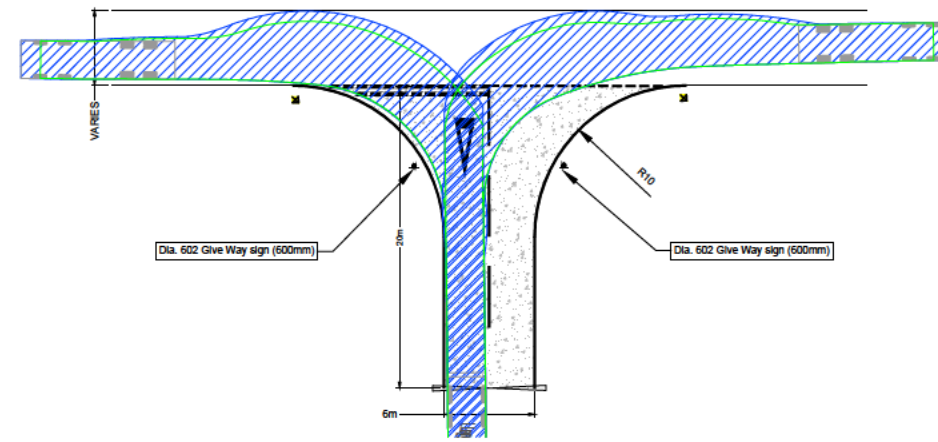

TYPE B ACCESS - LOW LOADER IN

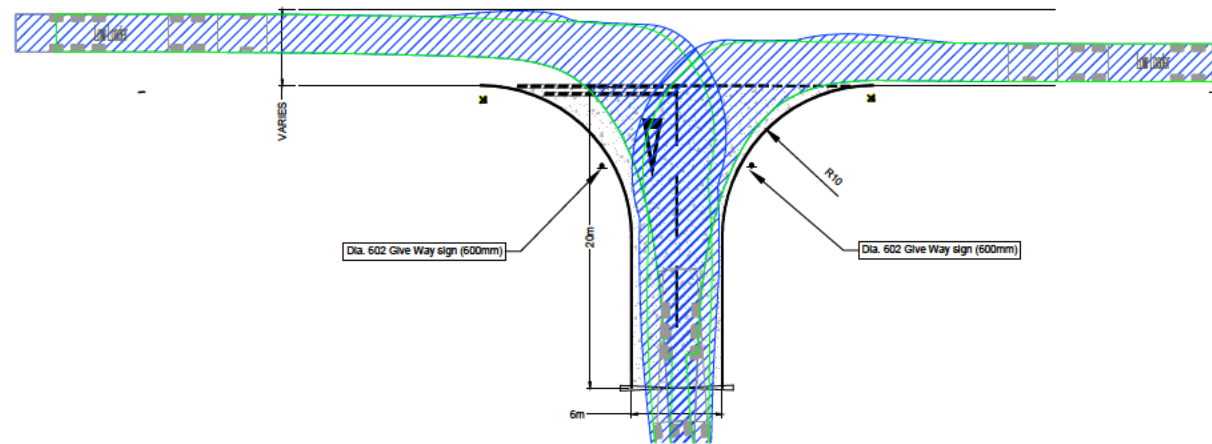

TYPE B ACCESS - LOW LOADER OUT

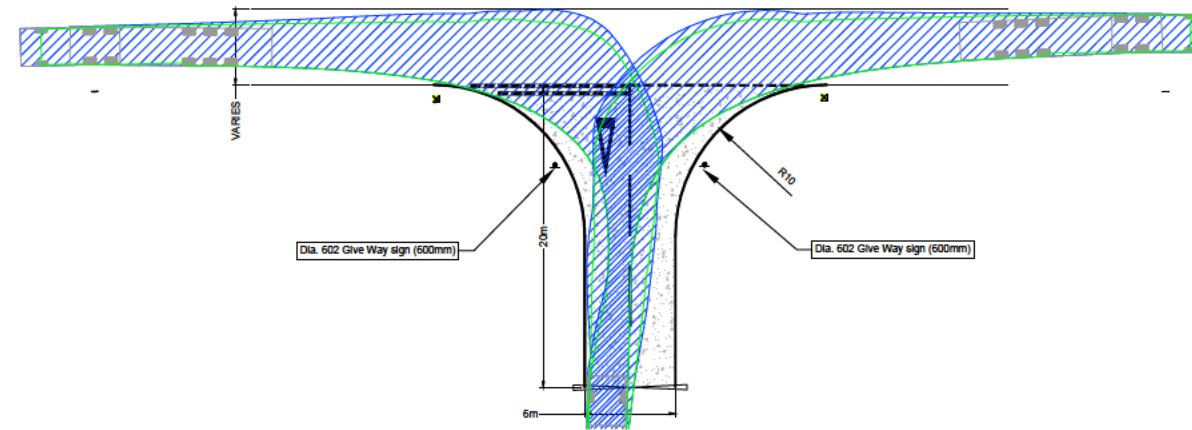

TYPE C ACCESS WITH OPPOSITE VERGE WIDENING

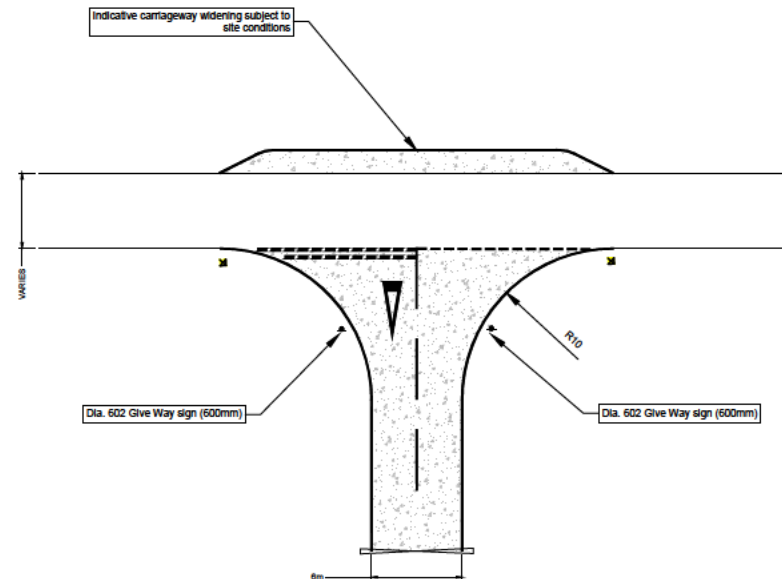

- NOTES
- Do not scale from this drawing. All dimensions are in metres unless noted otherwise.
 - Exact junction types and geometry to be determined from relevant section of Design Manual for Roads & Bridges (CD 123).
 - All road markings and signs to conform with the Traffic Signs Regulation and General Directions 2016 and Chapter 8.

- KEY
- EXISTING METELED ROAD BOUNDARY
 - PROPOSED ACCESS BOUNDARY/ROAD MARKINGS
 - PROPOSED GATE
 - PROPOSED PLASTIC DEMARCATION BOLLARD
 - PROPOSED POST MOUNTED TRAFFIC SIGN
 - PROPOSED ACCESS CONSTRUCTION

VEHICLE TRACKING

Large Tipper	
Overall Length	10.201m
Overall Width	2.500m
Overall Body Height	2.893m
Min Body Ground Clearance	0.343m
Max Track Width	2.500m
Lock to lock time	6.00s
Kerb to Kerb Turning Radius	11.550m

Low Loader	
Overall Length	16.833m
Overall Width	2.500m
Overall Body Height	3.306m
Min Body Ground Clearance	0.320m
Max Track Width	2.500m
Lock to lock time	6.00s
Kerb to Kerb Turning Radius	6.700m

- VEHICLE BODY SWEEP PATH (FORWARD GEAR)
- VEHICLE CHASSIS SWEEP PATH

REV	DATE	DESCRIPTION	BY	CHK	APP
REVISIONS					
CLIENT					
EQUINOR					
PROJECT					
DUDGEON & SHERINGHAM SHOAL OFFSHORE WIND FARM EXTENSIONS					
TITLE					
TYPE B & C ACCESS REDUCED JUNCTION WITH 20t TIPPER & LARGE LOW LOADER					
DRAWN					
J1		CHECKED	SKT	APPROVED	ADR
DATE	06.07.22	SCALE AT A3	1:500	CLIENTS REF.	
DRAWING No.	PB8164-RHD-ZZ-XX-GA-R-0011				REVISION
CLIENT DWG No.					D0.1

REVISIONS

CLIENT

EQUINOR

PROJECT
DUDGEON & SHERINGHAM SHOAL
OFFSHORE WIND FARM
EXTENSIONS

TITLE
TYPE B & C ACCESS
REDUCED JUNCTION WITH 20t
TIPPER & LARGE LOW LOADER

Westpoint, Peterborough Business Park,
Lynch Wood,
Peterborough PE2 6PZ
Tel: (0)1932 589556
www.royalhaskoningdhv.com

Royal HaskoningDHV
Enhancing Society Together

DRAWN	J1	CHECKED	SKT	APPROVED	ADR
-------	----	---------	-----	----------	-----

DATE	06.07.22	SCALE AT A3	1:500	CLIENTS REF.	
------	----------	-------------	-------	--------------	--

DRAWING No.	PB8164-RHD-ZZ-XX-GA-R-0011				REVISION
-------------	----------------------------	--	--	--	----------

CLIENT DWG No.					D0.1
----------------	--	--	--	--	------

- NOTES**
- Do not scale from this drawing, all dimensions are in metres unless noted otherwise.
 - Exact junction types and geometry to be determined from relevant section of Design Manual for Roads & Bridges (CD 123).
 - All road markings and signs to conform with the Traffic Signs Regulation and General Directions 2016 and Chapter 8.

- KEY**
- EXISTING METALED ROAD BOUNDARY
 - PROPOSED ACCESS BOUNDARY/ROAD MARKINGS
 - PROPOSED GATE
 - PROPOSED PLASTIC DEMARCATION BOLLARD
 - ▲ PROPOSED POST MOUNTED TRAFFIC SIGN
 - ▨ PROPOSED ACCESS CONSTRUCTION

TYPICAL HAUL ROAD CROSSING WITH NO TURNING MOVEMENTS ONTO ALL-PURPOSE ROAD NETWORK

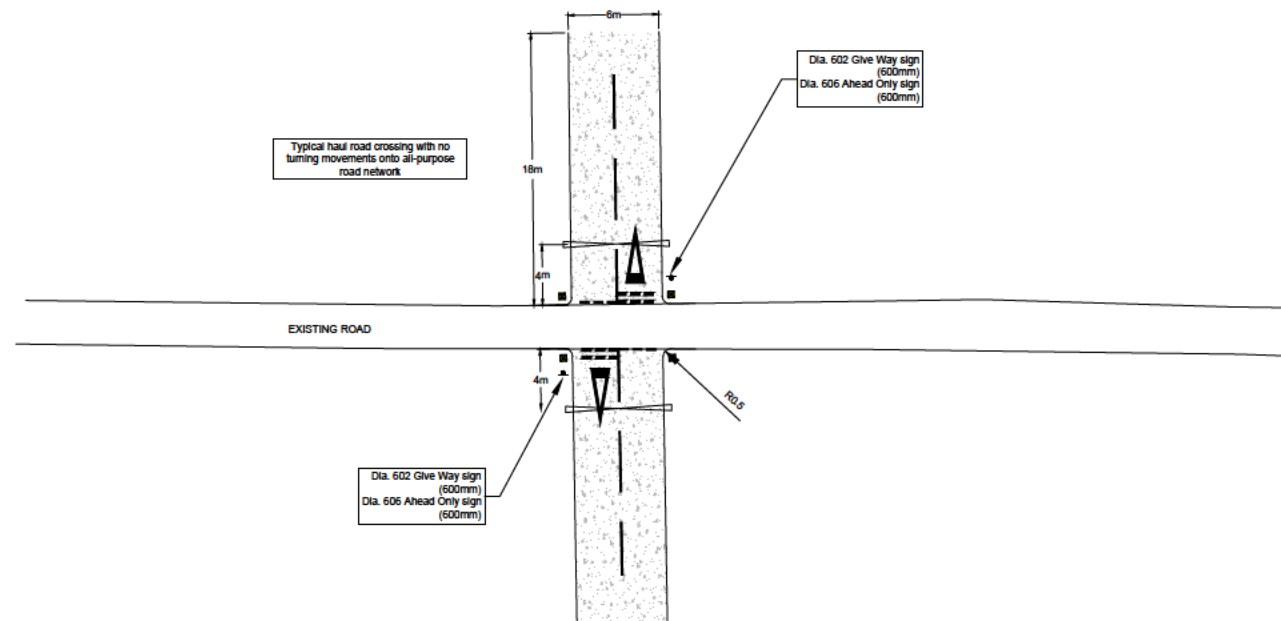

REV	DATE	DESCRIPTION	BY	CHK	APP
-----	------	-------------	----	-----	-----

REVISIONS

CLIENT

EQUINOR

PROJECT
DUDGEON & SHERINGHAM SHOAL
OFFSHORE WIND FARM
EXTENSIONS

TITLE
TYPE D ACCESS
TYPICAL ROAD CROSSINGS



DRAWN	JI	CHECKED	SKT	APPROVED	ADR
DATE	06.07.22	SCALE AT A3	1:500	CLIENTS REF.	
DRAWING No.	PB8164-RHD-ZZ-XX-GA-R-0012				REVISION
CLIENT DWG No.					D0.1

Annex C (Road Crossing Schedule)

Crossing ID	Obstacles	Obstacle description	Proposed crossing technique
6	A-Road	A149 The Street (Weybourne)	Trenchless
14	Minor Road	Holt Road (south of Weybourne)	Trenchless
21	Minor Road	Station Road (south of Weybourne)	Trenchless
52	A-Road	A148 Holt Road (east of Bodham)	Trenchless
60	Minor Road	The Street (south east of Bodham)	Trenchless
67	Minor Road	Rectory Road (south of Bodham)	Open Cut
74	Minor Road	New Road (south of West Beckham)	Open Cut
79	Minor Road	Marple Lane (east of Baconsthorpe)	Trenchless
84	Minor Road	Gresham Road (east of Baconsthorpe)	Open Cut
89	Minor Road	Church Lane (south east of Baconsthorpe)	Open Cut
99	Minor Road	Northfield Lane (north east of Plumstead)	Trenchless
109	Minor Road	Matlaske Road (east of Plumstead)	Open Cut / Trenchless
113	Minor Road	Little Barningham Road (north west of Little Barningham)	Open Cut
120	Minor Road	Sweetbriar Lane (west of Little Barningham)	Open Cut
122	Minor Road	Matlaske Road (south of Little Barningham)	Open Cut
133	Minor Road	Matlaske Road (south of Little Barningham)	Open Cut
144	Minor Road	Matlaske Road (north east of Saxthorpe)	Trenchless
162	B-Road	B1354, Aylsham Road (north west of Oulton)	Trenchless
173	Minor Road	Spa Lane (north west of Oulton)	Trenchless
186	Minor Road	Spink's Lane (west of Oulton)	Trenchless
197	Track	Tree lined access track (south of Oulton)	Trenchless
202	Minor Road	The Street (south of Oulton)	Trenchless
206	Minor Road	Unnamed Road	Trenchless
214	B-Road	B1149 (north east of Cawston)	Trenchless
218	Minor Road	Birds Lane (north east of Cawston)	Open Cut
228	B-Road	B1145 Aylsham Road (east of Cawston)	Trenchless
232	Minor Road	Old Friendship Lane (south east of Cawston)	Open Cut
244	Minor Road	Norwich Road (south of Cawston)	Trenchless
247	Minor Road	Reepham Road (south of Cawston)	Trenchless
255	Minor Road	Church Lane (east of Brandiston)	Open Cut
264	Minor Road	Clay Lane (north east of Swannington)	Open Cut
274	Minor Road	Church Road (east of Swannington)	Trenchless
283	Minor Road	Upgate (south east of Swannington)	Open Cut / Trenchless
293	Minor Road	Reepham Road (north of Attlebridge)	Open Cut / Trenchless
301	Minor Road	Felthorpe Road (east of Attlebridge)	Open Cut
305	Minor Road	Old Fakenham Road (Attlebridge)	Trenchless
307	A-Road	A1067, Fakenham Road	Trenchless
322	Minor Road	Ringland Lane (east of Weston Longville)	Trenchless
355	A-Road	Proposed - Norwich Western Link Road	Trenchless
338	Minor Road	Weston Road (west of Ringland)	Open Cut
344	Minor Road	The Broadway (Weston Green)	Trenchless
349	Minor Road	Weston Road	Open Cut
355	Minor Road	Taverham Road (south of Ringland)	Trenchless
371	A-Road	A47	Trenchless
376	Minor Road	Church Lane (west of Easton)	Open Cut / Trenchless
390	Minor Road	Colton Road (west of Marlingford)	Trenchless
411	Minor Road	Chapel Street (east of Barford)	Trenchless
420	B-Road	B1108 Watton Road (east of Barford)	Trenchless
427	Minor Road	Burdock Lane (south east of Barford)	Open Cut
437	Minor Road	Skoyles Lane (south east of Wrampingham)	Open Cut
445	Minor Road	Melton Road (north east of Wymondham)	Trenchless
466	B-Road	B1172 Ketts Oak (north east of Wymondham)	Trenchless
475	A-Road	A11	Trenchless
484	Minor Road	High Street (Ketteringham)	Trenchless
504	Minor Road	Hethersett Road (south of the A11)	Trenchless
522	Minor Road	Intwood Lane (west of Lower East Carleton)	Trenchless
542	B-Road	B1113, Main Road (Swardeston)	Trenchless
558	Minor Road	Swardeston Lane (south east of Swardeston)	Open Cut
568	Minor Road	Hickling Lane (north of Swainsthorpe)	Trenchless